

Low Voltage General Purpose Motors

LV Single phase motor section



ABB

Making you more competitive

ABB's General purpose motor is designed for use in general industry, meeting the demands of standard applications for OEM's. Motors are readily available from central stock locations and distributors around the world. The motors have high build quality, are available with all the features needed by the OEM market and can be modified to meet most specifications.



ABB is a global leader in power and automation technologies that enable utility and industry customers to improve their performance while lowering environmental impact. The ABB Group of companies operates in around 100 countries and employs about 107,000 people.

Low Voltage General Purpose Motors

Sizes 56 to 400, from 0.055 to 630 kW

	Contents	Page	
1	General information	4	1
2	Aluminum motors	11	2
3	Steel motors	79	3
4	Cast iron motors	111	4
5	Open drip proof motors	145	5
6	Global motors	165	6
7	Brake motors	189	7
8	Single phase motors	215	8

ABB reserves the right to change the design, technical specification and dimensions without prior notice.

General information

Standards

ABB motors are of the totally enclosed and open drip proof, single or three phase squirrel cage type, built to comply with international IEC and EN standards. Motors conforming to other national and international specifications are also available on request.

All production units are certified to ISO 9001 international quality standard as well ISO 14000 environmental standard and confirm to all applicable EU Directives.

IEC / EN

Electrical	Mechanical
IEC/EN 60034-1	IEC 60072
IEC/EN 60034-2	IEC/EN 60034-5
IEC 60034-8	IEC/EN 60034-6
IEC 60034-12	IEC/EN 60034-7
	IEC/EN 60034-9
	IEC 60034-14



M000001



M000002



M000003



M000029

Motors for EU motor efficiency levels

A Europe-wide agreement will ensure that the efficiency levels of electric motors manufactured in Europe are clearly displayed. In contrast to the American legislation on motor efficiency the European agreement does not establish mandatory efficiency levels.

It basically establishes three classes giving motor manufacturers an incentive to qualify for a higher class.

ABB is one of only a handful of leading motor manufacturers in Europe to have a motor range to meet or exceed the minimum efficiencies stated in the highest level of the EU agreement of LV motors.

These efficiency levels apply to 2- and 4-pole, three phase squirrel cage induction motors rated for 400V, 50Hz with S1 duty class with the output 1.1 to 90 kW, which

account for the largest volume on the market.

The efficiency of motors from different manufacturers are collated in a database, EURODEEM, published by the European Commission. It is accessible over the Internet at <http://iamest.jrc.it/projects/eem/eurodeem.htm>.

EU efficiency classes for 2-pole motors

Output kW	2-pole Boarderline	
	EFF2/EFF3	EFF1/EFF2
1.1	76.2	82.8
1.5	78.5	84.1
2.2	81.0	85.6
3	82.6	86.7
4	84.2	87.6
5.5	85.7	88.6
7.5	87.0	89.5
11	88.4	90.5
15	89.4	91.3
18.5	90.0	91.8
22	90.5	92.2
30	91.4	92.9
37	92.0	93.3
45	92.5	93.7
55	93.0	94.0
75	93.6	94.6
90	93.9	95.0

EU efficiency classes for 4-pole motors

Output kW	4-pole Boarderline	
	EFF2/EFF3	EFF1/EFF2
1.1	76.2	83.8
1.5	78.5	85.0
2.2	81.0	86.4
3	82.6	87.4
4	84.2	88.3
5.5	85.7	89.2
7.5	87.0	90.1
11	88.4	91.0
15	89.4	91.8
18.5	90.0	92.2
22	90.5	92.6
30	91.4	93.2
37	92.0	93.6
45	92.5	93.9
55	93.0	94.2
75	93.6	94.7
90	93.9	95.0

ABB Three phase induction motors, 400 V 50 Hz - EU motor efficiency levels

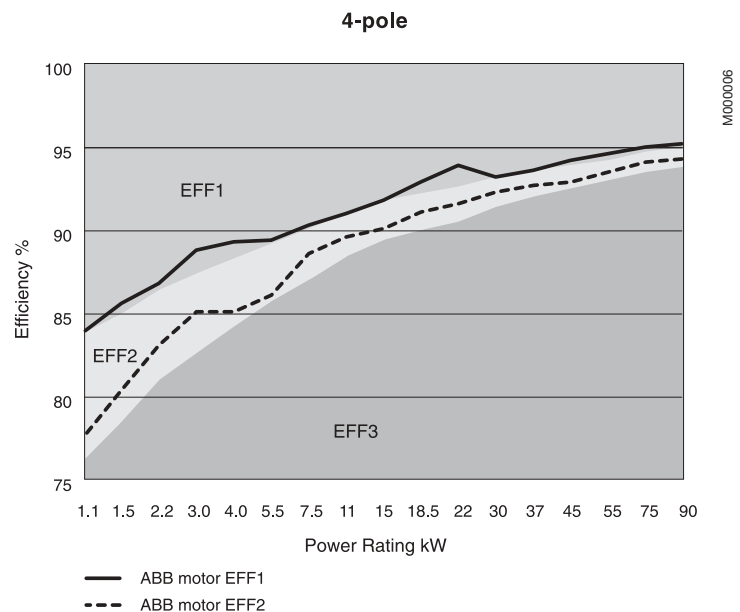
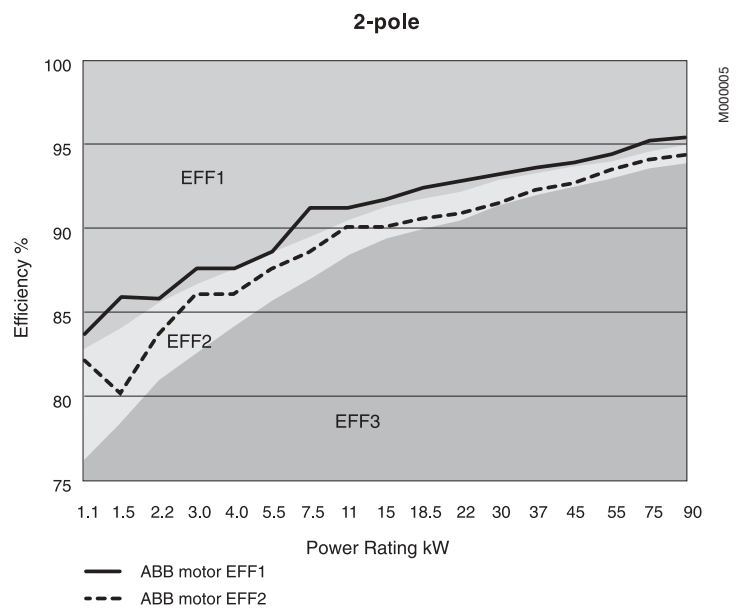

General technical specification

Mechanical and electrical design

Mounting arrangements

1

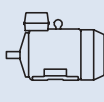
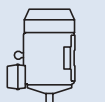
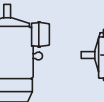
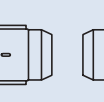
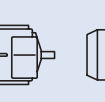
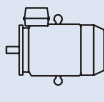
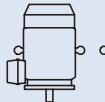
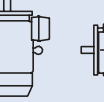
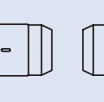
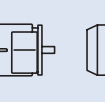
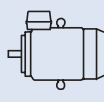
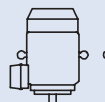
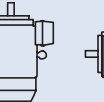
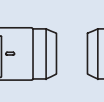
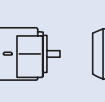
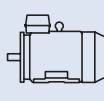
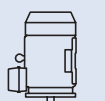
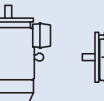
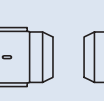
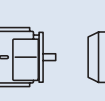
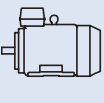
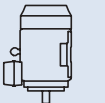
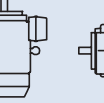
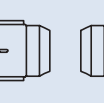
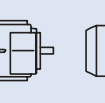
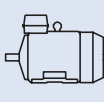
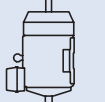
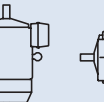
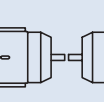
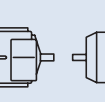
	Code/Code/Code						Product code pos. 12
Foot-mounted motor.	IM B3 IM 1001	IM V5 IM 1011	IM V6 IM 1031	IM B6 IM 1051	IM B7 IM 1061	IM B8 IM 1071	A = foot-mounted, term.box top R = foot-mounted, term.box RHS L = foot-mounted, term.box LHS
	M000007						
Flange-mounted motor, large flange	IM B5 IM 3001	IM V1 IM 3011	IM V3 IM 3031	*) IM 3051	*) IM 3061	*) IM 3071	B = flange mounted, large flange
	M000008						
Flange-mounted motor, small flange	IM B14 IM 3601	IM V18 IM 3611	IM V19 IM 3631	*) IM 3651	*) IM 3661	*) IM 3671	C = flange mounted, small flange
	M000009						
Foot- and flange-mounted motor with feet, large flange	IM B35 IM 2001	IM V15 IM 2011	IM V36 IM 2031	*) IM 2051	*) IM 2061	*) IM 2071	H = foot/flange-mounted, term.box top S = foot/flange-mounted, term.box RHS T = foot/flange-mounted, term.box LHS
	M000010						
Foot- and flange-mounted motor with feet, small flange	IM B34 IM 2101	IM V17 IM 2111	IM 2131	IM 2151	IM 2161	IM 2171	J = foot/flange-mounted, small flange
	M000011						
Foot-mounted motor, shaft with free extensions	IM 1002	IM 1012	IM 1032	IM 1052	IM 1062	IM 1072	
	M000012						

*) Not stated in IEC 60034-7.

Cooling

Designation system concerning methods of cooling refers to standard IEC 60034-6.

Example

IC 4 (A) 1 (A) 6

International Cooling ————|

Circuit arrangement ————|

0: Free circulation (open circuit)
4: Frame surface cooled

Primary coolant ————|

A for air (omitted for simplified designation)

Method of movement of primary coolant ————|

0: Free convection
1: Self-circulation
6: Machine-mounted independent component

Secondary coolant ————|

A for air (omitted for simplified designation)
W for water

Method of movement of secondary coolant ————|

0: Free convection
1: Self-circulation
6: Machine-mounted independent component
8: Relative displacement

Degrees of protection: IP code/IK code

Classification of degrees of protection provided by enclosures of rotating machines are refers to:

- Standard IEC 60034-5 or EN 60529 for IP code
- Standard EN 50102 for IK code

IP protection:

Protection of persons against getting in contact with (or approaching) live parts and against contact with moving parts inside the enclosure. Also protection of the machine against ingress of solid foreign objects. Protection of machines against the harmful effects due to the ingress of water

IP 5 5

Characteristic letter ————|

Degree of protection to persons and to parts of the motors inside the enclosure ————|

2: Motors protected against solid objects greater than 12 mm
4: Motors protected against solid objects greater than 1 mm
5: Dust-protected motors

Degree of protection provided by the enclosure with respect to harmful effects due to ingress of water ————|

3: Motors protected against spraying water
4: Motors protected against splashing water
5: Motors protected against water jets
6: Motors protected against heavy seas

IK code :

Classification of degrees of protection provided by enclosure for motors against external mechanical impacts.

IK 08

International mechanical protection ————|

Characteristic group ————|

Relation between IK code and impact energy:

IK cod	IK 0	IK 01	IK 02	IK 03	IK 04	IK 05	IK 06	IK 07	IK 08	IK 09	IK 10
Impact energy Joule	*	0.15	0.2	0.35	0.5	0.7	1	2	5	10	20

ABB Standard

** not protected according to EN 50102*

Insulation

ABB uses class F insulation systems, which, with temperature rise B, is the most common requirement among industry today.

The use of Class F insulation with Class B temperature rise gives ABB products a 25° C safety margin. This can be used to increase the loading by up to 12 per cent for limited periods, to operate at higher ambient temperatures or altitudes, or with greater voltage and frequency tolerances. It can also be used to extend insulation life. For instance, a 10 K temperature reduction will extend the insulation life.

Class F insulation system

- Max ambient temperature 40° C
- Max permissible temperature rise 105 K
- Hotspot temperature margin + 10 K

Class B rise

- Max ambient temperature 40° C
- Max permissible temperature rise 80 K
- Hotspot temperature margin + 10 K

Insulation system temperature class

- Class F 155° C
- Class B 130° C
- Class H 180° C

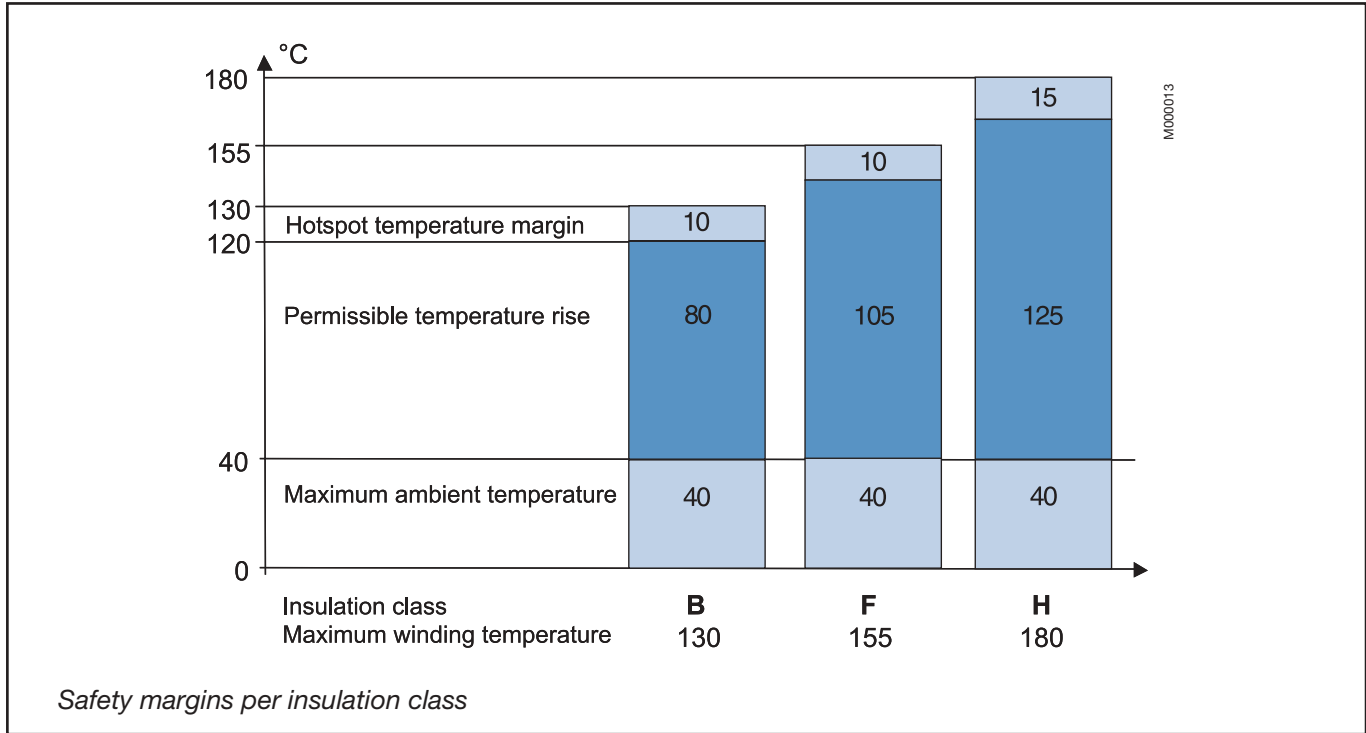

Frequency converter drives

Squirrel cage induction motors offer excellent availability, reliability and efficiency. With a frequency converter – a variable speed drive (VSD) – the motor will deliver even better value. A variable speed drive motor can be started softly with low starting current, and the speed can be controlled and adjusted to suit the application demand without steps over a wide range. Also the use of a frequency converter together with a squirrel cage motor usually leads to remarkable energy and environmental savings.

However, all motors are not suitable for variable speed drive. There are several points that have to be taken into account in the design and selection of the motor, if it is intended for variable speed operation.

Within the General purpose motor range ABB offers motors designed for both Direct On Line (DOL) and variable speed applications.

For more demanding applications the use of ABB Process performance motors is recommended.

When selecting general purpose motors to variable speed drives, following points shall be taken into consideration:

1. Dimensioning

The voltage (or current) fed by the frequency converter is not purely sinusoidal. This may increase the losses, vibration, and noise of the motor. Furthermore, a change in the distribution of the losses may affect to the temperature rise of the motor. In each case, the motor must be correctly sized according to the instructions supplied with the selected frequency converter.

When using ABB converters, please use ABB's DriveSize dimensioning programme or the loadability curves of the corresponding converter type for sizing the motors. The loadability curve for applicable General purpose motors used with ABB's ACS 800- frequency converters with DTC-control can be found in figure 3.

2. Speed range

In a frequency converter drive, the actual operating speed of the motor may deviate considerably from its nominal speed (i.e. the speed stamped on the rating plate).

For higher speeds, ensure that the highest permissible rotational speed of the motor or the critical speed of the entire equipment is not exceeded. When high speed operation exceeds the nominal speed of the motor, the following points should be checked:

- Maximum torque of the motor
- Bearing construction
- Lubrication
- Balancing
- Critical speeds
- Shaft seals
- Ventilation
- Fan noise

Guideline values of maximum speeds for General purpose aluminum motors described in figure 1. Exact values are available on request.

Figure 1. Guideline values of maximum speeds for General purpose motor in aluminum frame:

Motor size	Speed r/min	
	2-pole	4-pole
63-80	6000	4500
90-100	6000	6000
112-200	4500	4500
225-280	3600	3600

At low speed operation the cooling capacity of the fan decreases, which may cause higher temperature rises in the motor. A separate constant speed fan can be used to increase cooling capacity and loadability at low speed. It is also important to check the performance of the grease at low speeds.

3. Lubrication

Variable speed operation affects on the bearing temperature, which must be taken into account when selecting the lubrication method and grease type. For example the life time of sealed bearings can be remarkably shorter than in direct on line operation.

4. Insulation protection

Frequency converter supply causes higher voltage stresses at the windings of the motor than the sinusoidal supply. Thus, the insulation system and possible filters must be selected according to the used voltage and converter type. For selection of insulation system and filters, see figure 2.

5. Bearing currents

Bearing voltages and currents must be avoided in all motors. For reliability issues, insulated bearings and/or properly dimensioned filters at the converter output must be used according to the instructions in figure 2. When ordering, clearly state which alternative will be used.

For more information about bearing currents and voltages, please contact ABB.

6. Cabling, grounding and EMC

The use of a frequency converter puts higher demands on the cabling and grounding of the drive system. The motor must be cabled by using shielded symmetrical cables and cable glands providing 360° bonding (also called EMC-glands). For motors up to 30 kW unsymmetrical cables can be used, but shielded cables are always recommended.

More information about grounding and cabling of a variable speed drive can be found from the manual

“Grounding and cabling of the drive system” (Code: 3AFY 61201998 R0125 REV B) and the ABB’s Low Voltage Motors Manual.

For fulfilling the EMC requirements, special EMC cable(s) must be used in addition to the correct cable gland mounting, with special, extra earthing pieces. Please refer to the manuals of the frequency converter.

Validity of figure 2

Measures mentioned in Figure 2 apply to the applicable motors within the General motors range (not high-output versions) with ACS 800 and ACS 550 drives with uncontrolled DC-voltage. For other alternatives and converter types, please contact ABB.

Figure 2. Selection rules for insulation and filtering in variable speed drives

	Motor nominal power P_N or frame size		
	$P_N < 100 \text{ kW}$	$P_N \geq 100 \text{ kW}$ or IEC 315 \leq Frame size \leq IEC 355	$P_N \geq 350 \text{ kW}$ or IEC 400
$U_N \leq 500 \text{ V}$	Standard motor	Standard motor + Insulated N-bearing	Standard motor + Insulated N-bearing + Common mode filter
$U_N \leq 600 \text{ V}$	Standard motor + dU/dt-filter (reactor) OR Reinforced insulation	Standard motor + dU/dt-filter (reactor) + Insulated N-bearing OR Reinforced insulation + Insulated N-bearing	Standard motor + Insulated N-bearing + dU/dt-filter (reactor) + Common mode filter OR Reinforced insulation + Insulated N-bearing + Common mode filter
$U_N \leq 690 \text{ V}$	Reinforced insulation + dU/dt-filter (reactor)	Reinforced insulation + dU/dt-filter (reactor) + Insulated N-bearing	Reinforced insulation + Insulated N-bearing + dU/dt-filter (reactor) + Common mode filter

dU/dt filter (reactor)

Series reactor. DU/dt -filter decreases the changing rate of the phase and main voltages and thus reduces voltage stresses in the windings. DU/dt -filters also decrease so-called common mode currents and the risk of bearing currents.

Common mode

Common mode filters reduce so-called common mode currents in VSD applications and thus decrease the risk of bearing currents. Common mode filters do not significantly affect the phase or main voltages on the motor terminals.

Insulated Bearings

Bearings with insulated inner or outer races are used as the standard solution. So-called hybrid bearings, i.e. bearings with non-conductive ceramic balls, can also be used in special applications. More information for spare part selection is available on request.

Figure 3. Motor loadability with ACS 800, Field weakening point 50 Hz.

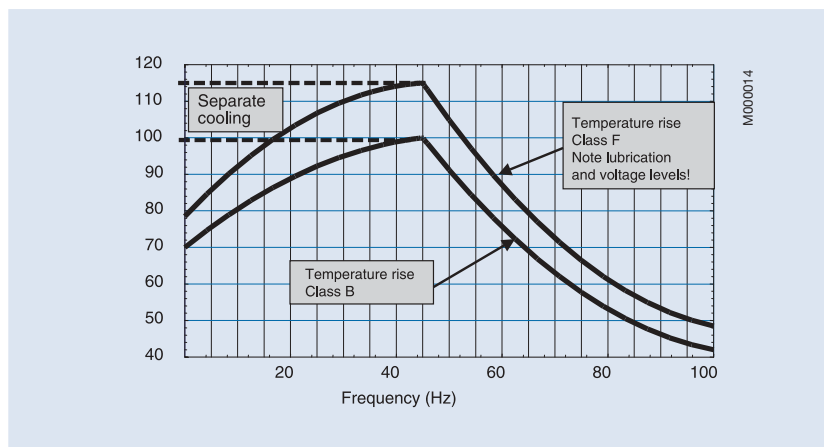

Single Phase Motors

Totally enclosed squirrel cage single phase low voltage motors,
Sizes 56 - 100, 0.065 to 2.2 kW

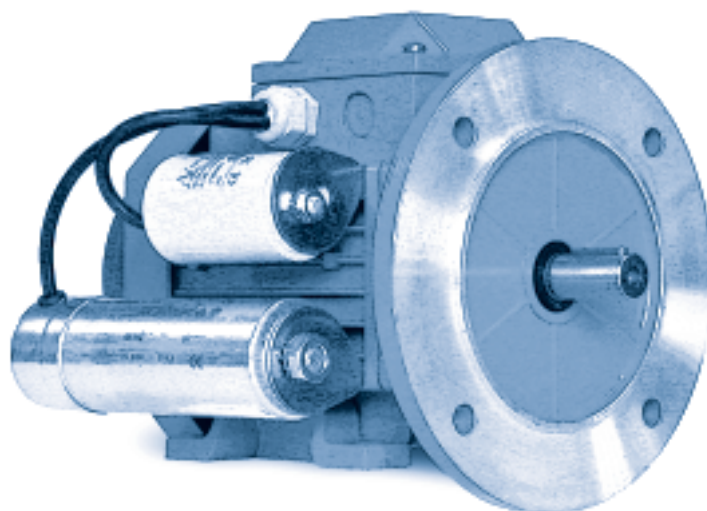

www.abb.com/motors&drives

- > Motors
- > Low voltage motors
- > General purpose motors

Mechanical design	216
Ordering information.....	222
Technical data.....	223
Rating plates.....	225
Variant codes	226
Dimension drawings.....	229
Single phase motors in brief	231

In many respects single phase motors have the same properties as three phase motors, and mechanically they meet the same standards. There are several types of single phase motors (CSR, PSC and PSC-reg.).

Each type has its benefits and limitations, as described in the section below.

Single phase motors are used in many industries and for many purposes.

Description and application

CSR

Starting and run capacitor

Single phase motor with attached run capacitor, starting capacitor and electronic start relay mounted in the terminal box.

The electronic start relay connects the starting capacitor instantly when the motor starts, and cuts out when the motor has reached its break-down torque. The connection time is limited to max. 2 sec., after which the starting capacitor is disconnected, regardless of whether the motor has reached its breakdown torque. The starter relay cannot reconnect until the mains voltage to the motor has been disconnected; this protects the starting capacitor and ensures that the motor can be protected with a thermal motor line circuit breaker.

The CSR motor with a starting torque of 140 - 160% is suitable for applications that require a high starting torque, such as compressors, hydraulic pumps that start with back pressure and centrifugal pumps where the shaft seal requires a high breakaway torque.

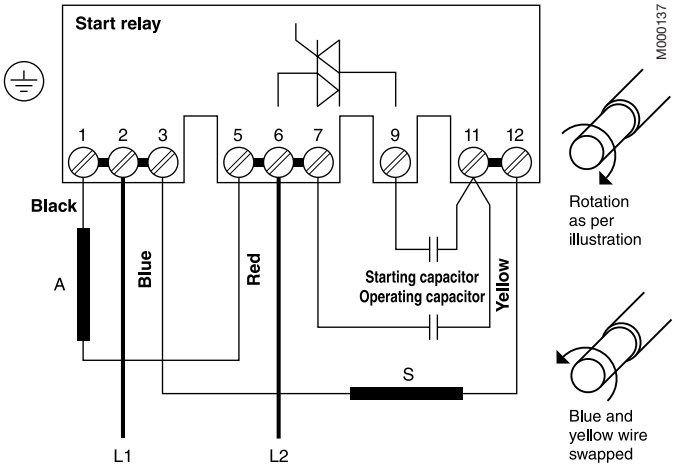

CSR model with electronic start relay.

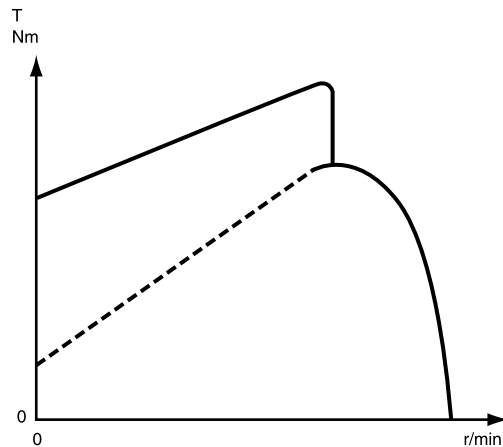

Torque curve for CSR motor.

PSC

Run capacitor

Single-phase motor with attached run capacitor. The starting torque is 30 - 70%, which makes this motor particularly suitable for applications with low starting torque requirements, such as fans, circular saws, polishing machines and centrifugal pumps where the shaft seal does not require a high breakaway torque.

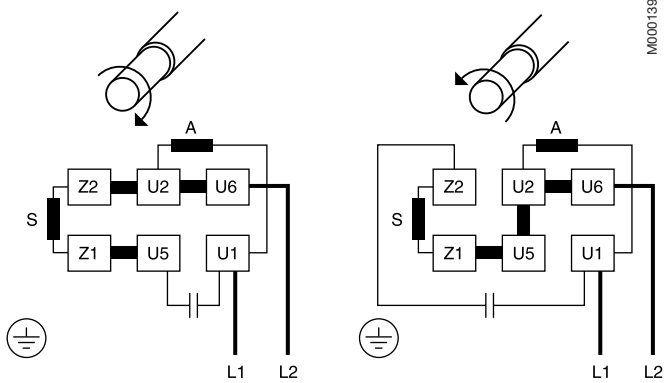

Basic PSC model.

PSC

for speed regulation

The motor's speed can be regulated by changing the voltage to the motor (twin-cable regulation) or by only changing the voltage to the circuit winding (three-cable regulation). The best regulation and the minimum loss in the motor is achieved only by changing the voltage to the circuit winding.

The voltage can be regulated using a transformer or a Triac control. The Triac control provides a greater loss in the motor and can contribute to noise in the motor.

To achieve good speed regulation it is important that the motor is suitable for the load. If the motor is too large for the load the regulation range will be small; at full speed the motor should not be loaded with less than 80% of its full load. With correct dimensioning it is possible to regulate speed down to approx. 30% of nominal speed.

Speed regulation is suitable for the following applications: fans where blades are mounted directly on the motor shaft and centrifugal pumps where the shaft seal does not require a high breakaway torque.

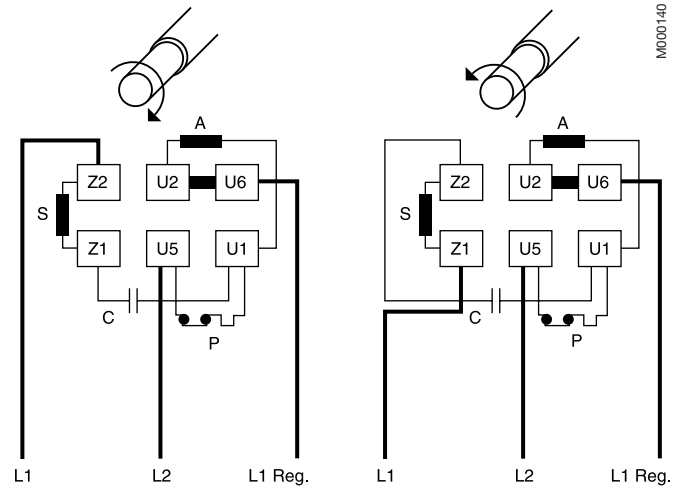

PSC model. Regulation of number of revolutions using electronic device (TRIAC).

Reversing

As a rule a single phase motor can only reverse when it stops completely before the rotational direction is changed. In CSR motors it is also important that the capacitor is discharged before the voltage is reconnected, as otherwise the starter relay will not connect the starter capacitor.

It is possible to design a PSC motor that is suitable for reversing. The motor has a joint start and circuit winding, which provides for very simple switching.

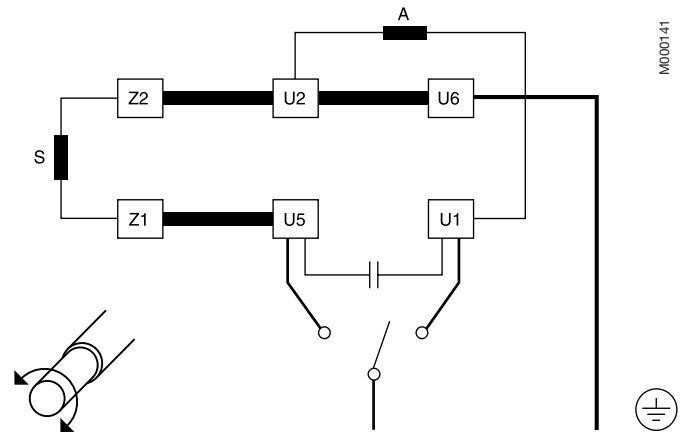

No load

Standard single phase motors cannot run idle for a long period. The losses are greater when running idle than at full load. If the motor is to run idle for a long period, specially designed windings must be produced.

Mechanical design

Stator

Stator framework, bearing shields and feet are made of aluminum alloy with low copper content.

Drain holes

Motors that will be operated in very humid or wet environments, and especially under intermittent duty, should be provided with drain holes. The appropriate IM designation, such as IM 3031, is specified on the basis of the method of mounting the motor.

In the basic design motors are supplied with drain holes as standard (see diagram below) on both D-end and N-end.

When mounting the motors, it should be ensured that the drain hole faces downwards. In the case of vertical mounting, the upper plug must be hammered home. In very dusty environments both plugs should be hammered home.

See variant codes 065 and 066 under the heading "Drain holes".

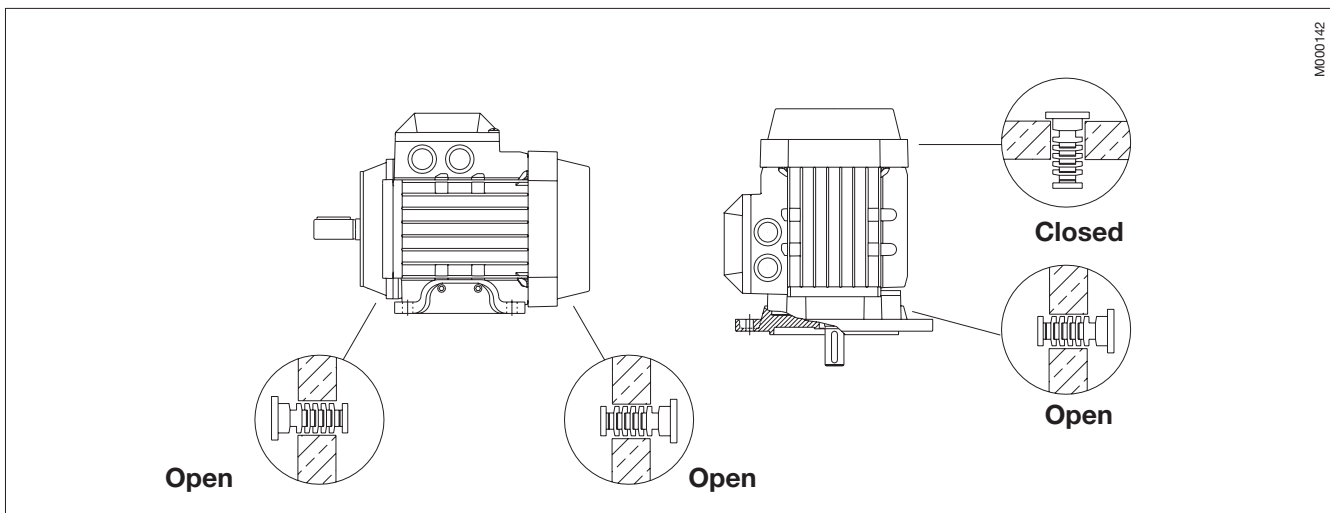

Terminal box and connections

Terminal box for sizes 56 to 63

The terminal box is made of aluminum and is located on top of the stator as standard. It is provided with two knockout openings (one Pg and one metric) and can be turned 4x90°.

Cable glands are not included. The size of the box is the same in size 56 and 63.

Position of terminal box

Motor size	Terminal box		
	on top	right side	left side
56-63	standard	-	-
71-100	standard	on request	on request

Terminal box examples

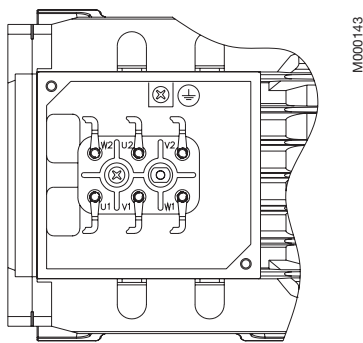

Motor sizes 56-80.

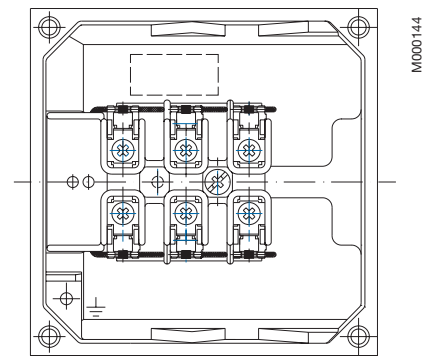

Motor sizes 90-100.

Terminal box for sizes 71 to 100

The terminal box is made of aluminum and is located either on the top of the motor, or on either side of the motor. The lower part of the box is integrated with the stator and allows cable entries from both sides.

It is provided with two knockout openings on each side. Cable glands are not included.

Degree of protection of standard terminal box is IP 55.

Connections

The terminal block is provided with 6 terminals for connecting Cu-cable. The terminals are marked in accordance with IEC 60034-8.

Connection openings

Motor size	Opening	Metric cable entry	Cable diameter, mm, min-max	Terminal bolt size	Maximum connectable Cu-cable area, mm ²
56-63	Knock-out opening	1 x M16 x 1.5; 1 x Pg 11	5-12	M4	2.5
71-80	Knock-out opening	2 x M20 x 1.5; 1 x Pg 16	8-15	M4	4
90-100	Knock-out opening	2 x (M25 + M20) x 1.5	11-16	M4	2.5 (for PCS) or 1.5 (for CSR)

Bearings

The motors are provided with bearings, according to the tables on the right.

Motor size	Standard bearing type	
	D-end	N-end
56	6201-2Z/C3	6201-2Z/C3
63	6202-2Z/C3	6201-2Z/C3
71	6203-2Z/C3	6202-2Z/C3
80	6204-2Z/C3	6203-2Z/C3
90	6205-2Z/C3	6204-2Z/C3
100	6306-2Z/C3	6205-2Z/C3

Axially-locked bearings

The table on the right shows which of the motor's bearings is axially locked in the bearing seat. In motor sizes 56 to 80 the locking is done by an inner bearing circlip, in motor sizes 90 and 100 by an inner bearing cover.

Motor size	Foot-mounted motors	Flange-mounted motors	
		Large flange	Small flange
56-63	On request	On request	On request
71-80	On request	D-end	On request
90-100	D-end ¹⁾	D-end ¹⁾	D-end ¹⁾

¹⁾ A spring washer at N-end presses the rotor towards D-end.

Lifetime of bearing/grease

The motors are supplied with bearings that are lubricated for life with a bearing grease for use at normal temperatures in dry or humid environments.

The grease's operating temperature is between -40 and +160°C. See also variant code 039 under the heading "Bearings and Lubrication".

The life time of the grease L10 is defined as the number of operating hours after which 90% of the bearings are sufficiently well lubricated. 50% of the bearings can achieve a grease life time that is twice as long.

The maximum life time of the grease should, however, be considered to be 40,000 hours, equivalent to around 5 years.

Motor size	No. of poles	Hours
56-80	2-6	40.000
90	2	30.000
90	4-6	40.000
100	2	28.000
100	4-6	40.000

8

Pulley diameter

When the desired bearing life has been determined, the minimum permissible pulley diameter can be calculated with FR, according to the formula:

$$D = \frac{1.9 \cdot 10^7 \cdot K \cdot P}{n \cdot FR}$$

Where:

D = diameter of pulley, mm

P = power requirement, kW

n = motor speed, r /min

K = belt tension factor, dependent on belt type and type of duty. A common value for V belts is K= 2.5

FR = permissible radial force

Permissible loading on shaft

The table below shows the permitted radial force in Newtons at zero axial force.

The permitted load of combined radial and axial force is available on request.

The bearing's life time, L_{10} , is calculated according to SKF's new theory on the life time of bearings, L_{10aah} , which also takes into account the purity of the grease.

If the radial force is applied between points X_0 and X_{max} , the permissible force F_R can be calculated from the following formula:

$$F_R = F_{X_0} - \frac{X}{E} (F_{X_0} - F_{X_{max}})$$

E = length of shaft extension in basic version

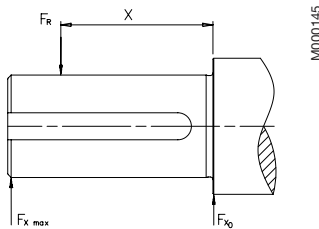

Permissible radial forces

Motor size	No. of poles	Length of shaft extension E (mm)	Ball bearings			
			Basic design with deep groove ball bearings			
			25,000 hours		40,000 hours	
			F_{X_0} (N)	$F_{X_{max}}$ (N)	F_{X_0} (N)	$F_{X_{max}}$ (N)
56	2	20	240	200	260	200
56	4	20	300	200	280	200
56	6-8	20	340	280	340	280
63	2-4	30	490	400	490	400
71	2-6	30	680	570	680	570
80	2-6	40	930	750	930	750
90	2-6	50	1010	810	1010	810
100	2-6	60	2280	1800	2280	1800

Permissible axial forces

The following tables give the permissible axial forces in Newton, assuming zero radial force.

The permitted load of combined radial and axial force is available on request.

Mounting arrangement IM B3

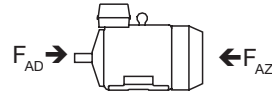

Motor size	25,000 hours						40,000 hours					
	2-pole		4-pole		6-pole		2-pole		4-pole		6-pole	
	F_{AD} N	F_{AZ} N	F_{AD} N	F_{AZ} N	F_{AD} N	F_{AZ} N	F_{AD} N	F_{AZ} N	F_{AD} N	F_{AZ} N	F_{AD} N	F_{AZ} N
56	470	230	520	280	540	300	430	190	470	230	480	240
63	790	390	865	465			720	320	780	380		
71	985	485	1070	570	1135	635	900	400	970	470	1020	520
80	1305	705	1420	820	1505	905	1185	585	1285	685	1350	750
90	1360	930	1490	1070	1590	1165	1225	800	1335	915	1415	990
100	2805	1945	3075	2215	3260	2400	2540	1680	2760	1900	2910	2050

Mounting arrangement IM V1

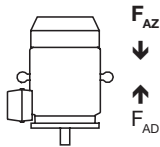

Motor size	25,000 hours						40,000 hours					
	2-pole		4-pole		6-pole		2-pole		4-pole		6-pole	
	F_{AD} N	F_{AZ} N	F_{AD} N	F_{AZ} N	F_{AD} N	F_{AZ} N	F_{AD} N	F_{AZ} N	F_{AD} N	F_{AZ} N	F_{AD} N	F_{AZ} N
56	470	230	520	270	540	290	430	190	470	230	480	240
63	790	380	875	455			725	310	790	370		
71	998	470	1085	555	1150	620	910	385	985	455	1035	505
80	1320	685	1445	790	1530	880	1200	565	1310	655	1375	725
90	1390	900	1525	1035	1625	1130	1225	770	1370	880	1450	955
100	2855	1890	3135	2155	3320	2340	2590	1625	2820	1840	2970	1990

Ordering information

Sample order

When placing an order, please state the following minimum data in the order, as in the example.

The product code of the motor is composed in accordance with the following example.

Motor type	M3VD 80C
Pole number	2
Mounting arrangement (IM-code)	IM B3 (IM 1001)
Rated output	1.4 kW
Product code	3GVD 081003-ASB
Variant codes if needed	

A	B	C	D, E, F	G	A	Motor type
M3VD	80	C	3GVD 081 003	- ASB, 122, 053, etc.	C	Product code
			1 2 3 4 5-6 7 8-10 11 12 13 14...		D	Mounting arrangement code
					E	Voltage/frequency code
					F	Generation code
					G	Variant codes

Explanation of the product code

Positions 1 and 2

3G = Business area LV Motors

Position 3 and 4

Enclosure and stator frame material

A, V = Totally enclosed motor with aluminum stator frame

Position 4

Motor type

D = Single-phase motor - CSR

E = Single-phase motor - PSC

Positions 5 and 6

IEC size

05 = 56

06 = 63

07 = 71

08 = 80

09 = 90

10 = 100

Position 7

Speed (pole pairs)

1 = 2 poles

2 = 4 poles

3 = 6 poles

Positions 8 to 10

Serial number

Position 11

- (dash)

Position 12

Mounting arrangement

A = Foot-mounted motor.

B = Flange-mounted motor.

Large flange with clearance holes.

C = Flange-mounted motor.

Small flange with threaded holes.

H = Foot- and flange-mounted motor.

Large flange with clearance holes.

J = Foot- and flange-mounted motor.

Small flange with threaded holes.

N = Flange-mounted (CI ring flange FF).

P = Foot- and flange-mounted motor.

(CI ring flange FF).

V = Flange-mounted motor. Special flange.

Position 13

Voltage/frequency code

S = 230-240 V 50 Hz.

X = Other rated voltage, connection or frequency.

Position 14

B, E = Generation code

The product code must be, if needed, followed by variant codes.

General purpose single phase motors

PSC motors, starting torque 30-70 %

IP 55 – IC 411 – Insulation class F, temperature rise class B

Output kW	Type designation	Product code	Speed r/min	Efficiency %	Power factor cos φ	Current		Torque			Capacitor Run μF	Moment of inertia J=1/4 GD ² kgm ²	Weight kg												
						I _N A	I _s A	T _N Nm	T _s Nm	T _{max} Nm															
3000 r/min = 2 poles													230 V 50 Hz												
0.065	M3VE 56 A	3GVE 051 001-••B	2830	39.0	0.86	0.87	2.5	0.22	0.4	1.9	4	0.00011	3.5												
0.09	M3VE 56 B	3GVE 051 002-••B	2820	43.0	0.84	1.15	2.6	0.31	0.4	1.8	4	0.00012	4												
0.12	M3VE 56 BB	3GVE 051 003-••B	2800	48.0	0.95	1.15	2.5	0.41	0.4	1.3	6	0.00012	4												
0.18	M3VE 63 A	3GVE 061 001-••B	2820	55.0	0.90	1.6	2.9	0.61	0.5	1.9	8	0.00016	5												
0.25	M3VE 63 B	3GVE 061 002-••B	2810	59.5	0.94	1.95	3.0	0.85	0.6	1.8	10	0.00036	5.5												
0.37	M3VE 71 A	3GVE 071 001-••B	2750	65.5	0.97	2.6	3.0	1.3	0.6	1.7	12	0.0004	6												
0.55	M3VE 71 B	3GVE 071 002-••B	2750	67.5	0.97	3.7	3.0	1.95	0.6	1.7	16	0.00045	7												
0.65	¹⁾ M3VE 71 C	3GVE 071 003-••B	2750	68.5	0.97	4.3	3.2	2.25	0.6	1.7	20	0.0005	7.5												
0.75	M3VE 80 A	3GVE 081 001-••B	2760	68.5	0.96	5	3.5	2.6	0.4	1.6	20	0.00072	9.5												
0.9	M3VE 80 B	3GVE 081 002-••B	2775	70.5	0.96	5.8	3.7	3.1	0.5	1.6	25	0.00076	11.5												
1.1	¹⁾ M3VE 80 C	3GVE 081 003-••B	2800	72.0	0.97	7.4	3.9	3.75	0.4	1.7	30	0.00109	12												
1.5	M3AE 90 L	3GAE 091 102-••E	2850	76.5	0.99	8.7	4.2	5.1	0.4	2.0	40	0.0024	16												
1500 r/min = 4 poles													230 V 50 Hz												
0.065	M3VE 56 A	3GVE 052 001-••B	1360	38.0	0.87	0.9	2.0	0.46	1.1	1.6	4	0.00018	4												
0.09	M3VE 56 B	3GVE 052 002-••B	1340	39.0	0.95	1.1	1.8	0.64	1.0	1.5	6	0.00018	4												
0.12	M3VE 63 A	3GVE 062 001-••B	1350	48.5	0.92	1.2	1.9	0.85	0.7	1.5	6	0.00026	5												
0.18	M3VE 63 B	3GVE 062 002-••B	1360	55.0	0.95	1.5	1.9	1.25	0.6	1.5	8	0.0003	5.5												
0.25	M3VE 71 A	3GVE 072 001-••B	1350	57.5	0.95	2	2.6	1.8	0.6	1.5	12	0.00066	6												
0.3	M3VE 71 B	3GVE 072 002-••B	1360	62.0	0.95	2.2	2.7	2.1	0.7	1.5	16	0.00089	7												
0.37	M3VE 71 C	3GVE 072 003-••B	1370	64.0	0.95	2.7	3.1	2.6	0.7	1.6	20	0.0011	7.5												
0.55	M3VE 80 A	3GVE 082 001-••B	1340	64.0	0.91	4.1	3.3	3.85	0.6	1.6	16	0.00125	9.5												
0.65	M3VE 80 B	3GVE 082 002-••B	1360	67.0	0.91	4.7	3.3	4.6	0.6	1.6	20	0.00156	11												
1.3	M3AE 90 L	3GAE 092 102-••E	1330	72.0	0.99	7.9	2.3	9.3	0.4	1.3	30	0.0043	16												
1.5	M3AE 90 LB	3GAE 092 103-••E	1340	73.0	0.99	9	2.3	10.6	0.4	1.3	40	0.0048	17												
1.85	M3AE 100 LA	3GAE 102 101-••E	1380	75.5	0.99	10.7	2.6	12.8	0.3	1.3	50	0.0069	21												
2.2	M3AE 100 LB	3GAE 102 102-••E	1400	78.5	0.99	12.2	3.1	14.9	0.3	1.6	50	0.0082	24												
1000 r/min = 6 poles													230 V 50 Hz												
0.12	M3VE 71 A	3GVE 073 001-••B	850	45.0	0.96	1.25	1.8	1.35	0.8	1.3	8	0.00063	6												
0.18	M3VE 71 B	3GVE 073 002-••B	860	48.0	0.96	1.7	1.9	2.1	0.8	1.4	10	0.00081	7												
0.25	M3VE 71 C	3GVE 073 003-••B	860	51.5	0.96	2.2	1.9	2.8	0.8	1.4	12	0.0011	7.5												
0.3	M3VE 80 A	3GVE 083 001-••B	900	56.5	0.91	2.5	2.5	3.2	0.7	1.5	12	0.00184	9.5												
0.37	M3VE 80 B	3GVE 083 002-••B	900	58.5	0.92	3	2.5	3.9	0.7	1.5	12	0.00217	10.5												
0.55	¹⁾ M3VE 80 C	3GVE 083 003-••B	880	59.5	0.90	4.5	2.5	6	0.7	1.4	16	0.00257	11.5												

¹⁾ Temperature rise class F.

The bullets in the product code indicate choice of mounting arrangement, voltage and frequency, generation code (see ordering information page).

General purpose single phase motors

PSC motors for speed regulation

IP 55 – IC 411 – Insulation class F, temperature rise class B

Output kW	Type designation	Product code	Speed r/min	Efficiency %	Power factor cos φ	Current		Torque		Capacitor	Moment of inertia J=1/4 GD ² kgm ²	Weight kg
						I _N A	I _S A	T _N Nm	T _S Nm	Run μF		
1500 r/min = 4 poles			230 V 50 Hz									
0.7	M3AE 90 S	3GAE 092 201-••E	1360	71.00	0.99	4.4	2.3	4.9	0.5	25	0.0032	13
0.9	M3AE 90 L	3GAE 092 202-••E	1370	73.50	0.99	5.4	2.3	6.3	0.4	30	0.0043	16
1000 r/min = 6 poles			230 V 50 Hz									
0.75	M3AE 90 L	3GAE 093 202-••E	850	64.50	0.99	5.1	1.8	8.35	0.5	30	0.0043	16

The bullets in the product code indicate choice of mounting arrangement, voltage and frequency, generation code (see ordering information page).

Rating plate

The standard rating plates is in aluminum. Rating plate is available in stainless steel, see variant code 098.

Motor sizes 56 to 71

ABB Motors		CE	
CL.F IP55 IEC 34	S2-15°		
Motor 1 ~ M3VE071B-6			
2100702-V			
KW 0.15	cos φ 0.99		
V 230 - 240	A 2.3		
r/min 930	Hz 50	Kg	
μF C RUN 20	/V 450		

M000146

Motor sizes 90 to 100

ABB Motors		CE	
3-Motor M3AD 090 L		CL.F IP 55	IEC 60034-1
3GAD092202-ASE			
N°.			
V	Hz	r/min	kw
230-240	50	1410	1,50
			A
			8,60
			Cos φ
			0,99
IM1081 CSR			
C RUN 40μF/400V		C START 130μF/330V	16 kg

M000147

Motor size 80

ABB Motors		CE	
Motor 1 CL.F IP55 IEC 34-1			
M3VE80C-4		1978314-V	
520000003105		Kw. 0.55	cos φ 0.95
V 230 - 240	3.90 A	r/min 1365	Hz 50
μF C RUN 20	V 450	Kg	

M000148

General purpose single phase motors – Variant codes

Code 1)	Variant	Motor size		
		56-63	71-80	90-100
Balancing				
052	Vibration acc. to grade A (IEC 60034-14).	P	P	P
423	Balancing without key.	P	P	P
424	Balancing with full key.	P	P	P
Bearings and lubrication				
036	Transport lock for bearings.	NA	NA	M
037	Roller bearing at D-end. Transport lock included.	NA	NA	M
039	Cold resistant grease. For bearing temperatures -55...+100°C.	M	M	M
040	Heat resistant grease. For bearing temperatures -25...+150°C. Mandatory for ambient temperatures > 50°C.	M	M	M
041	Bearings regreasable via grease nipples.	NA	NA	M
042	Internal bearing cover, locked at D-end.	NA	M	M
057	2RS bearings at both ends. Grease for bearing temperatures -20...+110°C.	M	M	M
058	Angular contact ball bearing at D-end, shaft force away from bearing. Transport lock included.	NA	NA	M
059	Angular contact ball bearing at D-end, shaft force away towards bearing. Transport lock included.	NA	NA	M
188	63-series bearings.	NA	NA	M
Branch standard design				
079	Silumin-alloy rotor cage.	NA	P	P
178	Stainless steel/acid proof bolts	M	M	M
209	Non-standard voltage or frequency (special winding)	P	P	P
425	Corrosion protected stator and rotor core.	P	P	M
Cooling system				
068	Metal fan.	NA	M	M
075	Cooling method IC 418 (without fan).	P	P	P
183	Separate motor cooling (fan axial, N-end).	NA	M	R
Dimension drawing				
141	Binding dimension drawing.	M	M	M
Drain holes				
066	Modified drain hole position.	M	M	M
Earthing bolt				
067	External earthing bolt. Earthing screw for connection of external protective earth.	M	M	M
Heating elements				
	Motor size	Element capacity		
	56-71	8 W		
	80-100	25 W		
450	Heating element 100-120 V.	M	M	M
451	Heating element 200-240 V.	M	M	M

1) Certain variant codes cannot be used simultaneously.

S = Included as standard.
M = On modification of a stocked motor, or on new manufacture, the number per order may be limited.

P = New manufacture only.
R = On request.
NA = Not applicable.

Code 1)	Variant	Motor size		
		56-63	71-80	90-100
Insulation systems				
014	Winding insulation class H (PSC-motors only).	P	P	P
Mounting arrangements				
008	IM 2101 foot/flange mounted, from IM 1001 (B34 from B3).	M	M	M
009	IM 2001 foot/flange mounted, from IM 1001 (B35 from B3).	M	M	M
047	IM 3601 flange mounted, IEC flange, from IM 3001 (B14 from B5).	M	M	M
048	IM 3001 flange mounted, IEC flange, from IM 3601 (B5 from B14).	M	M	M
078	IM 3601 flange-mounted, DIN C flange. Large flange with tapped holes. Larger flange than standard version.	NA	P	NA
080	IM 3001 flange-mounted, DIN A flange. Large flange with clearance holes. Larger flange than standard version.	NA	P	NA
200	Flange ring holder.	NA	P	M
217	Cast iron D-end shield.	NA	NA	M
218	Flange ring FT 85.	NA	P	M (only 90)
219	Flange ring FT 100.	NA	P	M (only 90)
220	Flange ring FF 100.	NA	P	M (only 90)
223	Flange ring FT 115.	NA	P	M (only 90)
224	Flange ring FF 115.	NA	P	M (only 90)
226	Flange ring FT 135.	NA	P	M
227	Flange ring FF 135.	NA	P	M
233	Flange ring FT 165.	NA	P	M
234	Flange ring FF 165.	NA	P	M
243	Flange ring FT 215.	NA	NA	M (only 100)
244	Flange ring FF 215.	NA	NA	M (only 100)
Painting				
114	Special paint colour, standard grade	M	M	M
179	Special paint specification.	NA	NA	R
Protection				
005	Protective roof, vertical motor, shaft down.	M	M	M
072	Radial seal at D-end.	P	P	M
073	Sealed against oil at D-end.	P	P	NA
158	Degree of protection IP 65.	M	M	P
211	Weather protected, IP xx W.	NA	NA	P
403	Degree of protection IP 56. Water from waves which splash over must not enter in serious quantities.	P	P	P
Rating & instruction plates				
002	Restamping voltage, frequency and output, continuous duty.	M	M	M
003	Individual serial number.	P	P	M
098	Stainless rating plate.	M	M	M
138	Mounting of additional identification plate.	M	M	M
139	Additional identification plate delivered loose.	M	M	M
161	Additional rating plate delivered loose.	M	M	M

1) Certain variant codes cannot be used simultaneously.

S = Included as standard.

M = On modification of a stocked motor, or on new manufacture, the number per order may be limited.

P = New manufacture only.

R = On request.

NA = Not applicable.

Code 1)	Variant	Motor size		
		56-63	71-80	90-100
Shaft and rotor				
069	Two shaft extensions as per basic catalogue. Standard shaft material.	P	P	P
070	One or two special shaft extensions, standard shaft material.	P	P	P
165	Shaft extension with open key-way.	P	P	P
410	Stainless/acid-proof steel shaft, standard or non-standard design. One or two shaft extensions.	P	P	P
Standards and regulations				
010	Fulfilling CSA Safety Certificate.	P	P	P
029	Fulfilling Underwriters Laboratory (UL) requirements.	NA	NA	P
Stator winding temperature sensors				
121	Bimetal detectors, break type (NCC), (3 in series), 130°C, in stator winding.	M	M	R
122	Bimetal detectors, break type (NCC), (3 in series), 150°C, in stator winding.	M	M	M
435	PTC-thermistors (3 in series), 130°C in stator winding.	M	M	M
436	PTC-thermistors (3 in series), 150°C in stator winding.	M	M	M
437	PTC-thermistors (3 in series), 170°C in stator winding.	M	M	M
Terminal box				
021	Terminal box LHS (seen from D-end).	NA	M	M
136	Extended cable connection, standard terminal box.	P	P	M
137	Extended cable connection, low terminal box.	P	P	P
180	Terminal box RHS (seen from D-end).	NA	M	M
230	Standard cable gland.	M	M	M
731	Two standard cable glands.	NA	M	M
Testing				
146	Type test with report for motor from specific delivery batch.	P	P	P
147	Type test with report for motor from specific delivery batch, customer witnessed.	P	P	P
148	Routine test report.	P	P	R
149	Test according to separate test specification.	NA	NA	R
221	Type test and multi-point load test with report for motor from specific delivery batch.	R	R	P
222	Torque/speed curve, type test and multi-point load test with report from specific delivery batch.	R	R	P
760	Vibration level test.	P	P	R
762	Noise level test.	P	P	P

1) Certain variant codes cannot be used simultaneously.

1) Certain variant codes cannot be used simultaneously.

S = Included as standard.
M = On modification of a stocked motor,
or on new manufacture,
the number per order may be limited.

P = New manufacture only.
R = On request.
NA = Not applicable.

General purpose single phase motors

Dimension drawings

Foot-mounted motor IM B3 (IM 1001)

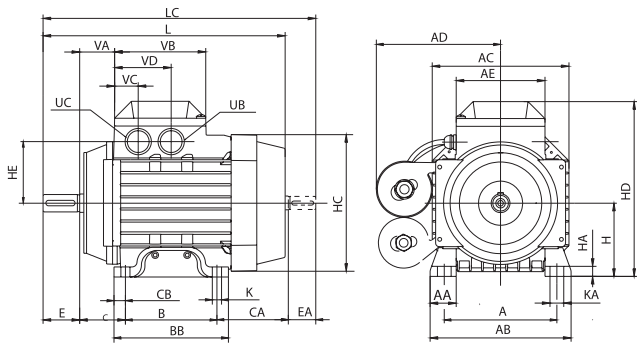

Flange-mounted motor IM B5 (IM 3001), large flange

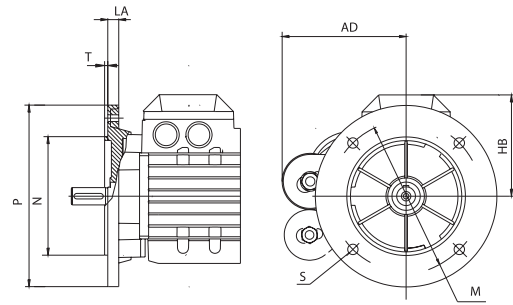

IM B14 (IM 3601), small flange

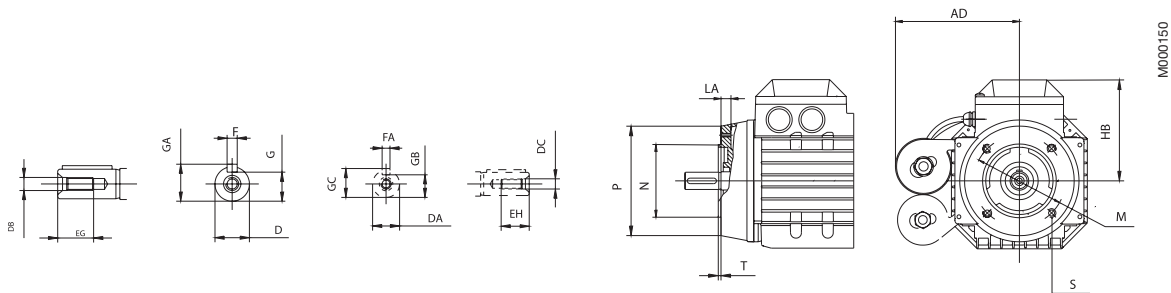

IM B3 (IM 1001)

Motor size	A	AA	AB	AC	AD	AE	B	BB	C	CA	CB	D	DA	DB	DC	E	EA	EG	EH	F	FA
56	90	18	108	110	110	72	71	85	36	78	7	9	9	M3	M3	20	20	9	9	3	3
63	100	26	120	120	110	72	80	96	40	71	8	11	11	M4	M4	23	23	10	10	4	4
71	112	24	136	130	125	85	90	110	45	78	10	14	11	M5	M4	30	23	13	10	5	4
80	125	28	154	150	130	97	100	125	50	80	12.5	19	14	M6	M5	40	30	16	13	6	5
90 S	140	27	170	177	140	110	100	125	56	81	12.5	24	14	M8	M5	50	30	19	12.5	8	5
90 L	140	27	170	177	135	110	125	150	56	81	12.5	24	14	M8	M5	50	30	19	12.5	8	5
100 L	160	32	197	197	155	110	140	172	63	91	16	28	19	M10	M6	60	40	22	19	8	6

Motor size	G	GA	GB	GC	H	HA	HC	HD	HE	K	KA	L	LC	UB	UC	VA	VB	VC	VD
56	7.2	10.2	7.2	10.2	56	8	110	159	71	5.8	9	197	225	Pg11	M16x1.5	30	72	26	53
63	8.5	12.5	8.5	12.5	63	10	120	171	76	7	11	205	237	Pg11	M16x1.5	36	72	26	53
71	11	16	8.5	12.5	71	9	130	176	63	7	10	238	266	Pg16	M20x1.5	35	92	22	57
80	15.5	21.5	11	16	80	10	150	190	67	10	15	265	300	Pg16	M20x1.5	37	100	26	61
90 S	20	27	11	16	90	10	177	217	82.5	10	14	282	317	M20x1.5	M25x1.5	43.5	110	33	67
90 L	20	27	11	16	90	10	177	217	82.5	10	14	307	342	M20x1.5	M25x1.5	43.5	110	33	67
100 L	24	31	15.5	21.5	100	12	197	237	92.5	12	15	349	394	M20x1.5	M25x1.5	47	110	33	67

IM B5 (IM 3001)

Motor size	HB	LA	M	N	P	S	T
56	103	10	100	80	120	7	3
63	108	10	115	95	140	10	3
71	105	10	130	110	160	10	3.5
80	110	12	165	130	200	12	3.5
90 S	127	10	165	130	200	12	3.5
90 L	127	10	165	130	200	12	3.5
100 L	137	11	215	180	200	15	4

IM B14 (IM 3601)

Motor size	HB	LA	M	N	P	S	T
56	103	10	65	50	80	M5	2.5
63	108	10	75	60	90	M5	2.5
71	105	10	85	70	105	M6	2.5
80	110	10	100	80	120	M6	3
90 S	127	13	115	95	140	M8	3
90 L	127	13	115	95	140	M8	3
100 L	137	14	130	110	160	M8	3.5

Tolerances

A, B	ISO js 14	F	ISO h9
C	± 0.8	H	+0 -0.5
D, DA	ISO j6	N	ISO j6

Above table gives the main dimensions in mm. For detailed drawings please see our web-site 'www.abb.com/motors&drives' or contact us.

General purpose single phase motors

Dimension drawings

Foot- and flange-mounted motor,
large flange IM B35 (IM 2001)

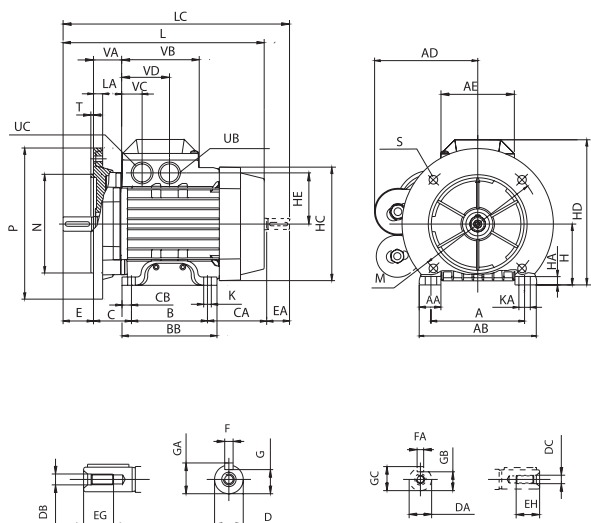

Foot- and flange-mounted motor,
small flange IM B34 (IM 2101)

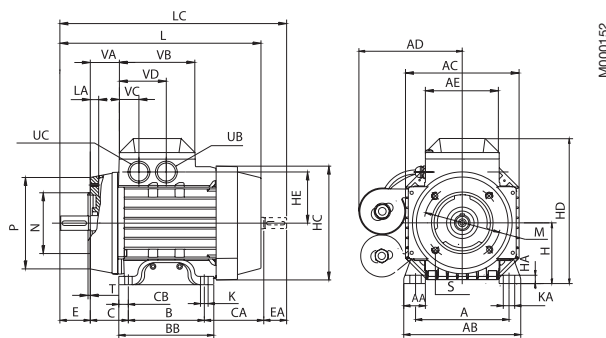

IM B35 (IM 2001); IM B34 (IM 2101)

Motor size	A	AA	AB	AC	AD	AE	B	BB	C	CA	CB	D	DA	DB	DC	E	EA	EG	EH	F	FA
56	90	18	108	110	110	72	71	85	36	78	7	9	9	M3	M3	20	20	9	9	3	3
63	100	26	120	120	110	72	80	96	40	71	8	11	11	M4	M4	23	23	10	10	4	4
71	112	24	136	130	125	85	90	110	45	78	10	14	11	M5	M4	30	23	13	10	5	4
80	125	28	154	150	130	97	100	125	50	80	12.5	19	14	M6	M5	40	30	16	13	6	5
90 S	140	27	170	177	140	110	100	125	56	81	12.5	24	14	M8	M5	50	30	19	12.5	8	5
90 L	140	27	170	177	135	110	125	150	56	81	12.5	24	14	M8	M5	50	30	19	12.5	8	5
100 L	160	32	197	197	155	110	140	172	63	91	16	28	19	M10	M6	60	40	22	19	8	6

Motor size	G	GA	GB	GC	H	HA	HC	HD	HE	K	KA	L	LC	UB	UC	VA	VB	VC	VD
56	7.2	10.2	7.2	10.2	56	8	110	159	71	5.8	9	197	225	Pg11	M16x1.5	30	72	26	53
63	8.5	12.5	8.5	12.5	63	10	120	171	76	7	11	205	237	Pg11	M16x1.5	36	72	26	53
71	11	16	8.5	12.5	71	9	130	176	63	7	10	238	266	Pg16	M20x1.5	35	92	22	57
80	15.5	21.5	11	16	80	10	150	190	67	10	15	265	300	Pg16	M20x1.5	37	100	26	61
90 S	20	27	11	16	90	10	177	217	82.5	10	14	282	317	M20x1.5	M25x1.5	43.5	110	33	67
90 L	20	27	11	16	90	10	177	217	82.5	10	14	307	342	M20x1.5	M25x1.5	43.5	110	33	67
100 L	24	31	15.5	21.5	100	12	197	237	82.5	12	15	349	394	M20x1.5	M25x1.5	47	110	33	67

IM 2001, IM B35

Motor size	HB	LA	M	N	P	S	T
56	103	10	100	80	120	7	3
63	108	10	115	95	140	10	3
71	105	10	130	110	160	10	3.5
80	110	12	165	130	200	12	3.5
90 S	127	10	165	130	200	12	3.5
90 L	127	10	165	130	200	12	3.5
100 L	137	11	215	180	250	15	4

IM 2101, IM B34

Motor size	HB	LA	M	N	P	S	T
56	103	10	65	50	80	M5	2.5
63	108	10	75	60	90	M5	2.5
71	105	10	85	70	105	M6	2.5
80	110	10	100	80	120	M6	3
90 S	127	13	115	95	140	M8	3
90 L	127	13	115	95	140	M8	3
100 L	137	14	130	110	160	M8	3.5

Tolerances

A, B	ISO js 14	F	ISO h9
C	± 0.8	H	+0 -0.5
D, DA	ISO j6	N	ISO j6

Above table gives the main dimensions in mm.
For detailed drawings please see our web-site
'www.abb.com/motors&drives' or contact us.

General purpose single phase motors in brief, basic design

Motor size		56	63	71	80	90	100
Stator and feet	Material	Die-cast aluminum alloy. Feet integrated with stator in sizes 63; loose feet in sizes 56 and 71-100.					
	Surface treatment	One-component modified polyester powder paint. Munsell blue 8B 4.5/3.25 / NCS 4822 BO5G, $\geq 30 \mu\text{m}$. / RAL 5014					
Bearing end shields	Material	Die-cast aluminum alloy.					
	Surface treatment	One-component modified polyester powder paint. Munsell blue 8B 4.5/3.25 / NCS 4822 BO5G, $\geq 30 \mu\text{m}$. / RAL 5014					
Bearings	D-end	6201-2Z/C3	6202-2Z/C3	6203-2Z/C3	6304-2Z/C3	6205-2Z/C3	6306-2Z/C3
	N-end	6201-2Z/C3	6201-2Z/C3	6202-2Z/C3	6203-2Z/C3	6204-2Z/C3	6205-2Z/C3
Axially locked bearings	Internal bearing cap	1)	1)	1)	1)	D-end	D-end
		1) By foot-mounted motors and motors with small flange: A spring washer in N-end presses the rotor against D-end.					
Bearing seals	D-end	V ring.					
	N-end	Labyrinth seal.					
Lubrication		Permanently lubricated bearings. Grease temperature (-30...+150°C).					
Terminal box	Material	Die-cast aluminum alloy.					
	Surface treatment	Similar to stator.					
	Screws	Steel 5 G, galvanised and yellow chromated.					
Connections	Connection openings	4 x M16		4 x M20		2 x (M25 + M20)	
	Terminal box	Screw terminal, 6 terminals.					
	Max Cu range, mm ²	PSC = 2.5. CSR = 1.5.					
Fan	Material	Polypropylene. Reinforced with 20% glass fibre.					
Fan hood	Material	Metal.					
Stator winding	Material	Copper.					
	Impregnation	Polyester coating. Tropicalized.					
	Insulation class	Insulation class F.					
Rotor winding	Material	Die-cast aluminum.					
Balancing method		Half key balancing.					
Key ways		Closed key way.					
Heating elements	On request	8 W			25 W		
Drain holes		Standard.					
Enclosure		IP 55.					
Cooling method		IC 411.					

ABB Motors' total product offer

ABB offers several comprehensive ranges of AC motors and generators. We manufacture synchronous motors for even the most demanding applications, and a full range of low and high voltage induction motors. Our in-depth knowledge of virtually every type of industrial processing ensures we always specify the best solution for your needs.



Low voltage motors and generators

General purpose motor for standard applications

- Aluminum motors
- Steel motors
- Cast iron motors
- Open drip proof motors
- Global motors
- Brake motors
- Single phase motors
- Servomotors

Process performance motors for more demanding applications

- Aluminum motors
- Cast iron motors (IEC and NEMA)
- Motors for high ambient temperatures
- Permanent magnet motors
- High speed motors
- Wind turbine generators
- Smoke venting motors
- Water cooled motors
- Motors for roller table drives

Motors for hazardous areas

- Flameproof motors
- Increased safety motors
- Non-sparking motors
- Dust ignition proof motors

Marine motors

- Aluminum motors
- Steel motors
- Cast iron motors
- Open drip proof motors

High voltage and synchronous motors and generators

- High voltage cast iron motors
- Induction modular motors
- Slip ring motors
- Motors for hazardous areas
- Synchronous motors and generators
- DC motors and generators



Motors & Drives

> Motors

>> Low Voltage Motors

>>> General purpose motors

- Aluminum motors
- Steel motors
- Cast iron motors
- Open drip proof motors
- Global motors
- Brake motors
- Single phase motors

>>> Process performance motors

>>> Motors for hazardous areas

>>> Marine motors

>>> Other applications

- NEMA motors
- Permanent magnet motors
- Smoke venting motors
- Roller table motors
- Water cooled motors
- Fan application motors
- Roller table motors

> Generators

Low Voltage Motors

Manufacturing sites (*) and some of the larger sales companies.

Australia

ABB Australia Pty Ltd
601 Blackburn Road
Notting Hill VIC 3168
Tel: +61 (0) 8544 0000
Fax: +61 (0) 8544 0001

Austria

ABB AG
Clemens Holzmeisterstrasse 4
AT-1810 Wien
Tel: +43 (0) 1 601 090
Fax: +43 (0) 1 601 09 8305

Belgium

Asea Brown Boveri S.A.-N.V.
Hoge Wei 27
BE-1930 Zaventem
Tel: +32 (0) 2 718 6311
Fax: +32 (0) 2 718 6657

Canada

ABB Inc., BA Electrical Machines
10300 Henri-Bourassa Blvd, West,
Saint-Laurent, Quebec
Canada H4S 1N6
Tel: +1 514 832-6583
Fax: +1 514 332-0609

China*

ABB Shanghai Motors Co., Ltd.
88 Tianning Road
Minhang(Economical and Techno-
logical Development Zone)
200245 Shanghai
Tel: +86 21 5472 3133
Fax: +86 21 5472 5025

Chile

Asea Brown Boveri S.A.
P.O.Box 581-3
Santiago
Tel: +56 (0) 2 5447 100
Fax: +56 (0) 2 5447 405

Denmark

ABB A/S
Automation Products
Emil Neckelmanns Vej 14
DK-5220 Odense SØ
Tel: +45 65 47 70 70
Fax: +45 65 47 77 13

Finland*

ABB Oy
Motors
P.O.Box 633
FI-65101 Vaasa
Tel: +358 (0) 10 22 11
Fax: +358 (0) 10 22 47372

France

ABB Entrelec
ZA La Boisse BP 90145
300 Rue des Prés-Seigneurs
FR-01124 Montluel Cedex
Tel: +33 4 37 40 40 00
Fax: +33 4 37 40 40 72

Germany

ABB Automation Products GmbH
Motors & Drives
Wallstaedter Strasse 59
DE-68526 Ladenburg
Tel: +49 (0) 6203 717 717
Fax: +49 (0) 6203 717 600

Hong Kong

ABB (Hong Kong) Ltd.
Tai Po Industrial Estate,
3 Dai Hei Street,
Tai Po, New Territories,
Hong Kong
Tel: +852 2929 3838
Fax: +852 2929 3505

India*

ABB Ltd.
32, Industrial Area, N.I.T
Faridabad 121 001
Tel: +91 (0) 129 502 3001
Fax: +91 (0) 129 502 3006

Indonesia

PT. ABB Sakti Industri
JL. Gajah Tunggal Km.1
Jatiuwung, Tangerang 15136
Banten, Indonesia
Tel: +62 21 590 9955
Fax: +62 21 590 0115 - 6

Ireland

Asea Brown Boveri Ltd
Components Division
Belgard Road
Tallaght, Dublin 24
Tel: +353 (0) 1 405 7300
Fax: +353 (0) 1 405 7327

Italy*

ABB SACE SpA
LV Motors
Via dell' Industria 18
IT-20010 Vittuone, Milano
Tel: +39 02 90341
Fax: +39 02 9034 7289

Japan

ABB K.K.
26-1 Cerulean Tower
Sakuragaoka-cho, Shibuya-ku
Tokyo 150-8512
Tel: +81 (0) 3 578 46251
Fax: +81 (0) 3 578 46260

Korea

ABB Korea Ltd.
7-9fl, Oksan Bldg., 157-33
Sungshung-dong, Kangnam-ku
Seoul
Tel: +82 2 528 2329
Fax: +82 2 528 2338

Malaysia

ABB Malaysia Sdn. Bhd.
Lot 608, Jalan SS 13/1K
47500 Subang Jaya, Selangor
Tel: +60 3 5628 4888
Fax: +60 3 5631 2926

Mexico

ABB México, S.A. de C.V.
Apartado Postal 111
CP 54000 Tlalnepantla
Edo. de México, México
Tel: +52 5 328 1400
Fax: +52 5 390 3720

The Netherlands

ABB B.V.
Dept. LV motors (APP2R)
P.O.Box 301
NL-3000 AH Rotterdam
Tel: +31 (0) 10 4078 879
Fax: +31 (0) 10 4078 345

Norway

ABB AS
P.O.Box 154 Vollebakk
NO-0520 Oslo
Tel: +47 22 872 000
Fax: +47 22 872 541

Russia

ABB Industrial & Building Systems
Ltd.
Business Centre "Krugozor"
Obruchevea 30/1, Building 2
Moscow 117861
Tel: +7 495 960 2200, 956 93 93
Fax: +7 495 960 2209, 230 63 46

Singapore

ABB Industry Pte Ltd
2 Ayer Rajah Crescent
Singapore 139935
Tel: +65 6776 5711
Fax: +65 6778 0222

Spain*

Asea Brown Boveri S.A.
Automation Products - Fábrica
Motores
P.O.Box 81
ES-08200 Sabadell
Tel: +34 93 728 8500
Fax: +34 93 728 8741

Sweden*

ABB Automation Technologies AB
LV Motors
SE-721 70 Västerås
Tel: +46 (0) 21 329 000
Fax: +46 (0) 21 329 140

Switzerland

ABB Schweiz AG
Normelec/CMC Components
Motors&Drives
Badenerstrasse 790
Postfach
CH-8048 Zürich
Tel: +41 (0) 58 586 0000
Fax: +41 (0) 58 586 0603

Taiwan

ABB Ltd.
6F, No. 126, Nanking East Road,
Section 41
Taipei, 105 Taiwan, R.O.C.
Tel: +886 (0) 2 2577 6090
Fax: +886 (0) 2 2577 9467

Thailand

ABB Limited (Thailand)
161/1 SG Tower,
Soi Mahadlekluang 3,
Rajdamri, Bangkok 10330
Tel: +66 2 665 1000
Fax: +66 2 665 1042

The United Kingdom

ABB Ltd
Drives, Motors and Machines
Daresbury Park
Daresbury, Warrington
Cheshire, WA4 4BT
Tel: +44 (0) 1925 741 111
Fax: +44 (0) 1925 741 212

USA

ABB Inc.
Low Voltage Motors
16250 W. Glendale Drive
New Berlin, WI 53151
Tel: +1 262 785 3200
Fax: +1 262 780 8888

Venezuela

Asea Brown Boveri S.A.
P.O.Box 6649
Carmelitas,
Caracas 1010A
Tel: +58 (0) 2 238 2422
Fax: +58 (0) 2 239 6383



<http://www.abb.com/motors&drives>
<http://online.abb.com/motors&drives>



Catalog

Low voltage General performance motors

We provide motors and generators, services and expertise to save energy and improve customers' processes over the total lifecycle of our products, and beyond.

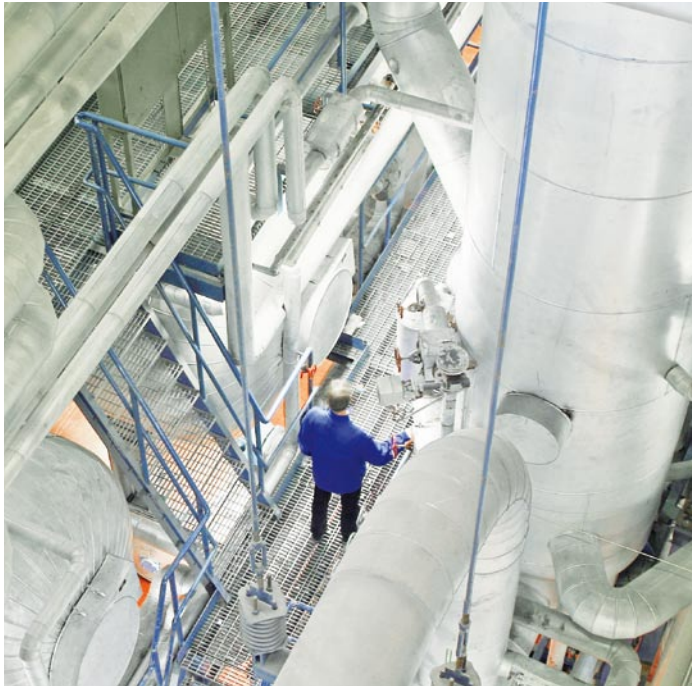

General performance motors

Sizes 56 to 250, from 0.06 to 55 kW



ABB's General performance motors are best suited for applications where simplicity and off-the-shelf availability are paramount. With ABB quality and support these motors have the features appreciated by volume customers and serial OEM's. Motors have IE1 efficiency.

Motor range for aluminum motors is 56 to 250, 0.06 to 55 kW and cast iron motors 71 to 250, 0.25 to 55 kW.

Ordering information	04
Technical data	
– Aluminum	05
– Cast iron	08
Variant codes	10
Dimension drawings	
– Aluminum	12
– Cast iron	13
General performance motors in brief	
– Aluminum	14
– Cast iron	16

Ordering information

When placing an order, please state the following minimum data in the order, as in the example.

The product code of the motor is composed in accordance with the following example.

Motor type	M2AA 112 M
Pole number	4
Mounting arrangement (IM-code)	IM B3 (IM 1001)
Rated output	4 kW
Product code	3GAA 112 101-ADE
Variant codes if needed	

Motor size

A	B	C	D, E, F	
M2AA	112 M	3GAA 112 101	- ADE, 122, 451, etc.	
		1 2 3 4 5 6 7 8 9 10 11 12 13 14...		
A Motor type		D Code for mounting arrangement	E Voltage and frequency code	F Generation code followed by variant codes
B Motor size				
C Product code				

Explanation of the product code

Positions 1 to 4

3GAA =
Totally enclosed motor with aluminum stator frame
3GBA =
Totally enclosed motor with cast iron frame

Position 4

Type of rotor
A = Squirrel cage rotor

Positions 5 and 6

IEC size

05 = 56	13 = 132
06 = 63	16 = 160
07 = 71	18 = 180
08 = 80	20 = 200
09 = 90	22 = 225
10 = 100	25 = 250
11 = 112	

Position 7

Pole pairs
1 = 2 poles
2 = 4 poles
3 = 6 poles

Positions 8 to 10

Running number

Position 11

- (dash)

Position 12

Mounting arrangement

A = Foot-mounted motor
B = Flange-mounted motor. Large flange with clearance holes.
C = Flange-mounted motor. Small flange with tapped holes.
F = Foot- and flange-mounted motor. Special flange.
H = Foot- and flange-mounted motor. Large flange with clearance holes.
J = Foot- and flange-mounted motor. Small flange with tapped holes.
N = Flange-mounted (CI ring flange FF)
P = Foot- and flange-mounted motor (CI ring flange FF)

Position 13

Voltage and frequency

Single-speed motors

B 380 VΔ 50 Hz
D 400 VΔ, 415 VΔ, 690 VY 50 Hz
E 500 VΔ 50 Hz
F 500 VY 50 Hz
S 230 VΔ, 400 VY, 415 VY 50 Hz *)
T 660 VΔ 50 Hz
U 690 VΔ 50 Hz
X Other rated voltage, connection or frequency, 690 V maximum

Position 14

Version A,B,C... = Generation code followed by variant codes

*) M2AA 200 is not available for voltages less than 380 VD

General performance aluminum motors

Technical data for totally enclosed squirrel cage three phase motors

IE1

IP 55 - IC 411 - Insulation class F, temperature rise class B
IE1 efficiency class according to IEC 60034-30; 2008

Output kW	Motor type	Product code	Speed r/min	Efficiency IEC 60034-2-1; 2007			Power factor cos φ	Current		Torque			Moment of inertia J = 1/4 GD ² kgm ²	Weight kg	Sound pressure level L _{PA} dB
				Full load 100%	3/4 load 75%	1/2 load 50%		I _N A	I _s / I _N	T _N Nm	T _l / T _N	T _b / T _N			
3000 r/min = 2-poles			400 V 50 Hz			CENELEC-design									
0.09	M2AA 56 A	3GAA 051 001-••A	2820	59.8	53.3	47.9	0.69	0.31	3.9	0.3	2.9	2.7	0.00011	3.2	48
0.12	M2AA 56 B	3GAA 051 002-••A	2840	67.2	63.8	55.6	0.64	0.4	4.1	0.4	3.2	2.8	0.00012	3.4	48
0.18	M2AA 63 A	3GAA 061 001-••C	2820	75.0	72.0	66.1	0.62	0.55	4.2	0.6	3.5	3.1	0.00013	3.9	54
0.25	M2AA 63 B	3GAA 061 002-••C	2810	78.6	77.0	69.6	0.69	0.66	4.5	0.8	3.6	3.3	0.00016	4.4	54
0.37	M2AA 71 A	3GAA 071 001-••E	2800	71.6	72.3	70.2	0.76	0.98	5.1	1.3	3.0	2.9	0.00035	4.9	58
0.55	M2AA 71 B	3GAA 071 002-••E	2790	78.4	79.8	78.7	0.78	1.29	5.3	1.9	2.9	2.8	0.00045	5.9	58
0.75	M2AA 80 A	3GAA 081 001-••E	2820	78.8	79.6	77.9	0.79	1.73	5.1	2.5	3.4	3.0	0.00069	8.5	60
1.1	M2AA 80 B	3GAA 081 002-••E	2760	78.1	80.0	79.7	0.83	2.4	5.7	3.8	2.5	2.6	0.0009	10.5	60
1.5	M2AA 90 S	3GAA 091 001-••E	2895	78.5	77.2	71.6	0.75	3.6	6.4	4.9	2.3	3.0	0.0019	13	63
2.2	M2AA 90 L	3GAA 091 002-••E	2890	83.6	84.4	83.0	0.82	4.6	7.2	7.2	2.7	2.8	0.0024	16	63
3	M2AA 100 L	3GAA 101 001-••E	2905	85.4	85.8	84.4	0.81	6.2	7.5	9.8	2.6	3.2	0.0041	21	65
4	M2AA 112 M	3GAA 111 101-••E	2885	85.7	86.7	86.5	0.85	7.9	7.4	13.2	2.6	2.8	0.0061	26	67
5.5	M2AA 132 SA	3GAA 131 001-••E	2845	85.8	86.4	86.0	0.87	10.6	6.8	18.4	2.8	3.2	0.014	38	75
7.5	M2AA 132 SB	3GAA 131 002-••E	2860	87.0	88.0	86.0	0.89	13.9	7.2	25.0	3.0	3.4	0.016	43	73
11	M2AA 160 MLA	3GAA 161 041-••G	2921	88.2	89.0	88.1	0.89	20.2	6.3	35.9	1.7	2.7	0.038	82	73
15	M2AA 160 MLB	3GAA 161 042-••G	2929	89.3	90.2	89.3	0.90	26.9	7.1	48.9	2.2	3.1	0.048	96	73
18.5	M2AA 160 MLC	3GAA 161 043-••G	2935	89.8	90.1	89.4	0.91	32.6	7.2	60.1	2.2	3.2	0.054	104	73
22	M2AA 180 MLA	3GAA 181 041-••G	2928	90.4	90.6	89.6	0.90	39	7.1	71.7	2.8	3.1	0.059	118	75
30	M2AA 200 MLA	3GAA 201 041-••G	2948	91.1	91.1	89.8	0.88	54	7.7	97.1	2.8	3.6	0.093	160	75
37	M2AA 200 MLB	3GAA 201 042-••G	2949	91.6	92.0	91.6	0.92	63.3	7.7	119	2.5	3.4	0.118	185	75
45	M2AA 225 SMA	3GAA 221 041-••G	2948	92.1	92.3	91.8	0.91	77.4	7.7	145	2.7	2.9	0.198	236	75
55	M2AA 250 SMA	3GAA 251 041-••G	2964	92.4	92.4	91.5	0.91	94.4	7.3	177	2.3	2.3	0.281	295	75
3000 r/min = 2-poles			400 V 50 Hz			High-output design									
11	M2AA 132 SMA	3GAA 131 005-••E	2890	89.0	90.4	90.6	0.87	20.5	7.5	36.3	2.5	3.1	0.0165	63	69
15	M2AA 132 SMC	3GAA 131 006-••E	2905	89.9	90.2	89.3	0.87	27.6	9.1	49.3	3.3	4.0	0.02	81	69
18.5	M2AA 132 SMD	3GAA 131 007-••E	2870	89.3	90.5	90.7	0.88	33.9	8.2	61.5	2.9	3.5	0.02356	89	68

The two bullets in the product code indicate choice of mounting arrangements, voltage and frequency code (see ordering information page).

I_s / I_N = Starting current
T_l / T_N = Locked rotor torque
T_b / T_N = Breakdown torque

Efficiency values are given according to IEC 60034-2-1; 2007.

Please note that the values are not comparable without knowing the testing method.

ABB has calculated the efficiency values according to indirect method, stray load losses (additional losses) determined from measuring.

General performance aluminum motors

Technical data for totally enclosed squirrel cage three phase motors

IE1

IP 55 - IC 411 - Insulation class F, temperature rise class B
IE1 efficiency class according to IEC 60034-30; 2008

Output kW	Motor type	Product code	Speed r/min	Efficiency IEC 60034-2-1; 2007			Power factor cos φ	Current		Torque			Moment of inertia J = 1/4 GD ² kgm ²	Weight kg	Sound pressure level L _{PA} dB
				Full load 100%	3/4 load 75%	1/2 load 50%		I _N A	I _s / I _N	T _N Nm	T _l / T _N	T _b / T _N			
1500 r/min = 4-poles			400 V 50 Hz			CENELEC-design									
0.06	M2AA 56 A	3GAA 052 001-••A	1340	51.1	45.8	36.0	0.67	0.25	2.5	0.4	2.2	2.2	0.00017	3.2	36
0.09	M2AA 56 B	3GAA 052 002-••A	1370	55.5	50.2	40.5	0.62	0.37	2.8	0.6	2.9	2.9	0.00018	3.4	36
0.12	M2AA 63 A	3GAA 062 001-••C	1400	65.5	60.4	51.7	0.57	0.46	3.1	0.8	2.7	2.8	0.00019	4	40
0.18	M2AA 63 B	3GAA 062 002-••C	1380	67.3	63.9	56.7	0.62	0.62	3.1	1.2	2.5	2.6	0.00026	4.5	40
0.25	M2AA 71 A	3GAA 072 001-••E	1365	65.1	66.0	62.7	0.76	0.72	4.0	1.7	2.0	2.1	0.00066	5.2	45
0.37	M2AA 71 B	3GAA 072 002-••E	1355	69.7	71.9	71.1	0.79	0.96	3.8	2.6	2.0	2.2	0.0008	5.9	45
0.55	M2AA 80 A	3GAA 082 001-••E	1375	74.1	75.9	75.0	0.78	1.37	4.5	3.8	1.9	2.2	0.0013	8.5	50
0.75	M2AA 80 B	3GAA 082 002-••E	1400	75.5	77.0	75.7	0.76	1.88	4.5	5.1	1.9	2.4	0.0019	10	50
1.1	M2AA 90 S	3GAA 092 001-••E	1420	77.2	78.1	76.0	0.77	2.6	4.8	7.3	2.0	2.6	0.0032	13	50
1.5	M2AA 90 L	3GAA 092 002-••E	1420	81.3	81.9	80.1	0.75	3.5	5.8	10.0	2.8	3.0	0.0043	16	50
2.2	M2AA 100 LA	3GAA 102 001-••E	1430	82.3	83.4	82.5	0.78	4.9	5.6	14.6	2.2	2.6	0.0069	21	64
3	M2AA 100 LB	3GAA 102 002-••E	1430	84.6	85.7	84.2	0.78	6.5	6.4	20.0	2.5	3.0	0.0082	24	66
4	M2AA 112 M	3GAA 112 101-••E	1430	86.0	87.1	86.8	0.80	8.3	6.4	26.7	2.3	2.6	0.01	29	60
5.5	M2AA 132 S	3GAA 132 001-••E	1450	86.5	87.0	86.1	0.75	12.2	5.6	36.2	2.1	2.6	0.031	42	66
7.5	M2AA 132 M	3GAA 132 002-••E	1450	88.6	89.2	88.4	0.75	16.2	6.1	49.3	2.3	2.7	0.038	49	66
11	M2AA 160 MLA	3GAA 162 041-••G	1459	88.2	89.0	88.4	0.81	22.2	6.5	71.9	2.3	2.6	0.068	84	65
15	M2AA 160 MLB	3GAA 162 042-••G	1462	89.2	89.8	89.2	0.82	29.6	7.1	97.9	2.6	3.3	0.085	98	65
18.5	M2AA 180 MLA	3GAA 182 041-••G	1465	89.8	90.3	89.8	0.82	36.2	7.7	120	2.6	3.1	0.103	116	65
22	M2AA 180 MLB	3GAA 182 042-••G	1463	90.4	90.9	90.5	0.83	42.3	7.7	143	2.9	3.5	0.122	131	65
30	M2AA 200 MLA	3GAA 202 041-••G	1475	91.1	91.5	91.0	0.83	57.2	7.3	194	2.4	3.0	0.22	187	67
37	M2AA 225 SMA	3GAA 222 041-••G	1477	91.6	91.9	91.4	0.84	69.4	6.9	239	2.3	2.7	0.317	231	68
45	M2AA 225 SMB	3GAA 222 042-••G	1478	92.1	92.4	91.9	0.84	83.9	7.4	290	2.4	3.0	0.374	257	68
55	M2AA 250 SMA	3GAA 252 041-••G	1478	92.4	92.7	92.2	0.85	101	7.4	355	2.7	2.7	0.485	297	68
1500 r/min = 4-poles			400 V 50 Hz			High-output design									
11	M2AA 132 SMA	3GAA 132 005-••E	1460	88.6	89.1	88.1	0.78	22.9	7.0	71.9	2.1	2.9	0.0381	76	69
15	M2AA 132 SMC	3GAA 132 006-••E	1455	89.2	89.7	89.3	0.78	31.1	7.2	98.4	2.4	3.3	0.0485	88	69

The two bullets in the product code indicate choice of mounting arrangements, voltage and frequency code (see ordering information page).

I_s / I_N = Starting current
T_l / T_N = Locked rotor torque
T_b / T_N = Breakdown torque

Efficiency values are given according to IEC 60034-2-1; 2007.

Please note that the values are not comparable without knowing the testing method.

ABB has calculated the efficiency values according to indirect method, stray load losses (additional losses) determined from measuring.

General performance aluminum motors

Technical data for totally enclosed squirrel cage three phase motors

IE1

IP 55 - IC 411 - Insulation class F, temperature rise class B
IE1 efficiency class according to IEC 60034-30; 2008

Output kW	Motor type	Product code	Speed r/min	Efficiency IEC 60034-2-1; 2007			Power factor cos φ	Current		Torque			Moment of inertia J = 1/4 GD ² kgm ²	Weight kg	Sound pressure level L _{PA} dB
				Full load 100%	3/4 load 75%	1/2 load 50%		I _N A	I _s I _N	T _N Nm	T _l T _N	T _b T _N			
1000 r/min = 6-poles			400 V 50 Hz			CENELEC-design									
0.09	M2AA 63 A	3GAA 063 001-••C	910	47.1	42.5	32.1	0.56	0.49	2.1	0.9	2.1	2.1	0.0002	4	38
0.12	M2AA 63 B	3GAA 063 002-••C	910	57.5	54.0	46.2	0.58	0.51	2.1	1.3	2.1	2.1	0.00027	4.5	38
0.18	M2AA 71 A	3GAA 073 001-••E	895	60.4	60.0	55.0	0.73	0.58	3.1	1.9	1.9	2.0	0.00092	5.5	42
0.25	M2AA 71 B	3GAA 073 002-••E	895	64.0	63.6	59.5	0.71	0.79	3.3	2.6	2.2	2.2	0.0012	6.5	42
0.37	M2AA 80 A	3GAA 083 001-••E	910	69.9	71.4	68.8	0.73	1.04	3.6	3.8	1.6	2.0	0.002	9	47
0.55	M2AA 80 B	3GAA 083 002-••E	905	72.1	73.4	71.2	0.69	1.59	3.3	5.8	1.8	1.9	0.0026	10	47
0.75	M2AA 90 S	3GAA 093 001-••E	925	71.5	70.9	65.9	0.64	2.3	3.6	7.7	2.1	2.4	0.0032	13	44
1.1	M2AA 90 L	3GAA 093 002-••E	915	72.9	73.4	70.0	0.63	3.4	3.2	11.4	1.9	2.1	0.0043	16	44
1.5	M2AA 100 L	3GAA 103 001-••E	950	79.6	79.9	77.5	0.69	3.9	4.2	15.0	2.0	2.3	0.0082	23	49
2.2	M2AA 112 M	3GAA 113 101-••E	960	82.8	82.5	79.5	0.66	5.8	5.1	21.8	2.3	2.8	0.01	28	54
3	M2AA 132 S	3GAA 133 001-••E	960	82.5	82.9	80.9	0.68	7.7	4.3	29.8	1.8	2.3	0.031	39	57
4	M2AA 132 MA	3GAA 133 002-••E	965	83.6	83.2	80.8	0.65	10.6	5.1	39.5	2.1	2.5	0.038	46	61
5.5	M2AA 132 MB	3GAA 133 003-••E	960	83.8	84.3	82.9	0.71	13.3	5.3	54.7	2.0	2.4	0.045	54	57
7.5	M2AA 160 MLA	3GAA 163 041-••G	968	85.4	86.3	85.8	0.77	16.4	6.4	73.9	1.8	3.0	0.071	84	61
11	M2AA 160 MLB	3GAA 163 042-••G	968	87.0	87.7	87.0	0.77	23.7	7.7	108	2.1	3.2	0.102	110	61
15	M2AA 180 MLA	3GAA 183 041-••G	968	88.1	88.6	87.7	0.75	32.7	7.7	147	2.3	3.8	0.139	137	61
18.5	M2AA 200 MLA	3GAA 203 041-••G	975	89.1	90.0	89.9	0.77	38.9	5.9	181	1.9	2.5	0.218	186	65
22 ¹⁾	M2AA 200 MLB	3GAA 203 042-••G	969	89.3	90.5	90.7	0.76	46.7	5.4	216	1.8	2.3	0.218	198	65
30	M2AA 225 SMA	3GAA 223 041-••G	985	90.6	91.0	90.4	0.83	57.5	7.0	290	2.4	2.8	0.547	257	65
37	M2AA 250 SMA	3GAA 253 041-••G	985	91.2	91.6	91.0	0.82	71.4	6.7	358	2.3	2.7	0.728	291	65
1000 r/min = 6-poles			400 V 50 Hz			High-output design									
7.5	M2AA 132 SMA	3GAA 133 006-E	950	84.7	86.1	86.3	0.73	17.5	4.9	75.3	1.7	2.1	0.0485	88	69

¹⁾ Temperature rise class F

The two bullets in the product code indicate choice of mounting arrangements, voltage and frequency code (see ordering information page).

I_s / I_N = Starting current
T_l / T_N = Locked rotor torque
T_b / T_N = Breakdown torque

Efficiency values are given according to IEC 60034-2-1; 2007.

Please note that the values are not comparable without knowing the testing method.

ABB has calculated the efficiency values according to indirect method, stray load losses (additional losses) determined from measuring.

General performance cast iron motors

Technical data for totally enclosed squirrel cage three phase motors

IE1

IP 55 - IC 411 - Insulation class F, temperature rise class B
IE1 efficiency class according to IEC 60034-30; 2008

Output kW	Motor type	Product code	Speed r/min	Efficiency IEC 60034-2-1; 2007			Power factor cos φ	Current		Torque			Moment of inertia J = 1/4 GD ² kgm ²	Weight kg	Sound pressure level L _{PA} dB
				Full load 100%	3/4 load 75%	1/2 load 50%		I _N A	I _s / I _N	T _N Nm	T _l / T _N	T _b / T _N			
3000 r/min = 2-poles			400 V 50 Hz			CENELEC-design									
0.37	M2BA 71 A	3GBA 071 101-••B	2705	69.2	73.5	73.7	0.80	0.96	3.9	1.3	2.2	2.3	0.00039	11	58
0.55	M2BA 71 B	3GBA 071 102-••B	2680	73.2	77.3	79.3	0.85	1.27	4.3	1.95	2.4	2.49	0.00051	11	56
0.75	M2BA 80 A	3GBA 081 101-••B	2820	78.1	79.1	77.9	0.81	1.71	5.9	2.5	2.3	2.7	0.0008	14	60
1.1	M2BA 80 B	3GBA 081 102-••B	2805	79.5	81.2	81.2	0.82	2.4	5.7	3.7	2.7	2.8	0.00101	16	60
1.5	M2BA 90 S	3GBA 091 101-••B	2890	82.2	82.5	80.3	0.81	3.2	7.2	4.9	2.5	3.0	0.00199	22	63
2.2	M2BA 90 L	3GBA 091 102-••B	2875	83.4	84.5	83.5	0.84	4.5	6.6	7.3	2.3	2.4	0.00254	24	63
3	M2BA 100 L	3GBA 101 101-••B	2910	83.2	83.4	81.4	0.83	6.2	7.0	9.8	2.7	3.2	0.00445	32	65
4	M2BA 112 M	3GBA 111 101-••B	2880	84.9	86.2	85.9	0.89	7.6	7.5	13.2	2.4	2.6	0.00531	37	67
5.5	M2BA 132 SA	3GBA 131 101-••B	2885	85.4	85.0	83.0	0.82	11.3	6.6	18.2	2.3	3.35	0.01029	61	75
7.5	M2BA 132 SB	3GBA 131 102-••B	2890	86.5	86.3	84.3	0.81	15.4	7.6	24.7	2.7	3.5	0.01275	68	73
11	M2BA 160 MLA	3GBA 161 041-••G	2921	88.2	89.0	88.1	0.89	20.2	6.3	35.9	1.7	2.7	0.038	118	73
15	M2BA 160 MLB	3GBA 161 042-••G	2929	89.3	90.2	89.3	0.90	26.9	7.1	48.9	2.2	3.1	0.048	132	73
18.5	M2BA 160 MLC	3GBA 161 043-••G	2935	89.8	90.1	89.4	0.91	32.6	7.2	60.1	2.2	3.2	0.054	140	73
22	M2BA 180 MLA	3GBA 181 041-••G	2928	90.4	90.6	89.6	0.90	39	7.1	71.7	2.8	3.1	0.059	167	75
30	M2BA 200 MLA	3GBA 201 041-••G	2948	91.1	91.1	89.8	0.88	54	7.7	97.1	2.8	3.6	0.093	213	75
37	M2BA 200 MLB	3GBA 201 042-••G	2949	91.6	92.0	91.6	0.92	63.3	7.7	119	2.5	3.4	0.118	239	75
45	M2BA 225 SMA	3GBA 221 041-••G	2948	92.1	92.3	91.8	0.91	77.4	7.7	145	2.7	2.9	0.198	296	75
55	M2BA 250 SMA	3GBA 251 041-••G	2964	92.4	92.4	91.5	0.91	94.4	7.3	177	2.3	2.3	0.281	338	75
1500 r/min = 4-poles			400 V 50 Hz			CENELEC-design									
0.25	M2BA 71 A	3GBA 072 101-••B	1365	68.3	70.8	69.7	0.81	0.65	3.5	1.74	1.9	2.0	0.00074	10	45
0.37	M2BA 71 B	3GBA 072 102-••B	1380	72.4	74.5	74.6	0.83	0.88	4.0	2.5	1.6	2.1	0.00088	11	45
0.55	M2BA 80 A	3GBA 082 101-••B	1415	74.5	73.8	70.0	0.73	1.45	5.0	3.7	2.0	2.8	0.00144	15	45
0.75	M2BA 80 B	3GBA 082 102-••B	1410	77.0	77.0	73.7	0.72	1.95	5.0	5.0	1.9	2.6	0.00198	16	50
1.1	M2BA 90 S	3GBA 092 101-••B	1410	78.4	79.6	78.4	0.79	2.5	4.8	7.4	1.9	2.3	0.0033	22	50
1.5	M2BA 90 L	3GBA 092 102-••B	1410	80.4	81.4	80.0	0.78	3.4	5.4	10.1	2.5	3.2	0.0044	25	50
2.2	M2BA 100 LA	3GBA 102 101-••B	1425	83.2	84.3	83.5	0.80	4.7	5.4	14.7	2.1	2.8	0.00873	34	64
3	M2BA 100 LB	3GBA 102 102-••B	1430	83.2	84.1	83.2	0.80	6.5	6.2	20.0	2.2	2.8	0.009	35	67
4	M2BA 112 M	3GBA 112 101-••B	1420	83.8	85.2	85.1	0.82	8.4	6.2	26.8	2.2	2.7	0.0106	39	60
5.5	M2BA 132 S	3GBA 132 101-••B	1460	87.8	87.8	85.9	0.76	11.8	6.0	35.9	1.8	2.7	0.02635	60	66
7.5	M2BA 132 M	3GBA 132 102-••B	1445	86.7	88.0	88.0	0.80	15.6	5.7	49.5	1.9	2.4	0.03282	70	66
11	M2BA 160 MLA	3GBA 162 041-••G	1459	88.2	89.0	88.4	0.81	22.2	6.5	71.9	2.3	2.6	0.068	120	65
15	M2BA 160 MLB	3GBA 162 042-••G	1462	89.2	89.8	89.2	0.82	29.6	7.1	97.9	2.6	3.3	0.085	134	65
18.5	M2BA 180 MLA	3GBA 182 041-••G	1465	89.8	90.3	89.8	0.82	36.2	7.7	120	2.6	3.1	0.103	115	65
22	M2BA 180 MLB	3GBA 182 042-••G	1463	90.4	90.9	90.5	0.83	42.3	7.7	143	2.9	3.5	0.122	165	65
30	M2BA 200 MLA	3GBA 202 041-••G	1475	91.1	91.5	91.0	0.83	57.2	7.3	194	2.4	3.0	0.22	240	67
37	M2BA 225 SMA	3GBA 222 041-••G	1477	91.6	91.9	91.4	0.84	69.4	6.9	239	2.3	2.7	0.317	292	68
45	M2BA 225 SMB	3GBA 222 042-••G	1478	92.1	92.4	91.9	0.84	83.9	7.4	290	2.4	3.0	0.374	317	68
55	M2BA 250 SMA	3GBA 252 041-••G	1478	92.4	92.7	92.2	0.85	101	7.4	355	2.7	2.7	0.485	341	68

The two bullets in the product code indicate choice of mounting arrangements, voltage and frequency code (see ordering information page).

I_s / I_N = Starting current
T_l / T_N = Locked rotor torque
T_b / T_N = Breakdown torque

Efficiency values are given according to IEC 60034-2-1; 2007.

Please note that the values are not comparable without knowing the testing method.

ABB has calculated the efficiency values according to indirect method, stray load losses (additional losses) determined from measuring.

General performance cast iron motors

Technical data for totally enclosed squirrel cage three phase motors

IE1

IP 55 - IC 411 - Insulation class F, temperature rise class B
IE1 efficiency class according to IEC 60034-30; 2008

Output kW	Motor type	Product code	Speed r/min	Efficiency IEC 60034-2-1; 2007			Power factor cos φ	Current		Torque			Moment of inertia J = 1/4 GD ² kgm ²	Weight kg	Sound pressure level L _{PA} dB
				Full load 100%	3/4 load 75%	1/2 load 50%		I _N A	I _s / I _N	T _N Nm	T _l / T _N	T _b / T _N			
1000 r/min = 6-poles			400 V 50 Hz			CENELEC-design									
0.18	M2BA 71 A	3GBA 073 101-••B	900	63.7	63.8	59.0	0.71	0.57	3.1	1.9	2.0	2.1	0.00089	10	42
0.25	M2BA 71 B	3GBA 073 102-••B	895	67.2	67.2	62.6	0.69	0.77	3.4	2.6	2.2	2.3	0.0011	12	42
0.37	M2BA 80 A	3GBA 083 101-••B	915	71.0	71.1	67.0	0.69	1.09	3.6	3.8	1.8	2.2	0.00187	15	47
0.55	M2BA 80 B	3GBA 083 102-••B	920	73.9	75.0	72.8	0.71	1.51	3.8	5.7	1.8	2.2	0.00239	17	47
0.75	M2BA 90 S	3GBA 093 101-••B	925	70.0	68.9	64.0	0.65	2.3	3.6	7.7	2.0	2.2	0.0033	22	44
1.1	M2BA 90 L	3GBA 093 102-••B	915	73.3	73.5	70.2	0.68	3.1	3.8	11.4	2.3	2.6	0.0044	25	44
1.5	M2BA 100 LA	3GBA 103 101-••B	945	76.0	77.6	76.5	0.69	4.1	4.0	15.1	2.0	2.4	0.00727	32	49
2.2	M2BA 112 M	3GBA 113 101-••B	945	81.2	82.2	80.7	0.71	5.5	5.1	22.2	2.0	2.4	0.0114	38	54
3	M2BA 132 S	3GBA 133 101-••B	970	83.5	83.8	81.9	0.69	7.5	7.0	29.5	1.6	2.2	0.03164	69	57
4	M2BA 132 MA	3GBA 133 102-••B	975	85.7	84.6	81.3	0.63	10.6	5.6	39.1	2.4	2.9	0.03336	70	57
5.5	M2BA 132 MB	3GBA 133 103-••B	960	86.3	87.3	86.7	0.73	12.6	4.6	54.7	1.7	2.1	0.0413	77	57
7.5	M2BA 160 MLA	3GBA 163 041-••G	968	85.4	86.3	85.8	0.77	16.4	6.4	73.9	1.8	3.0	0.071	120	61
11	M2BA 160 MLB	3GBA 163 042-••G	968	87.0	87.7	87.0	0.77	23.7	7.7	108	2.1	3.2	0.102	156	61
15	M2BA 180 MLA	3GBA 183 041-••G	968	88.1	88.6	87.7	0.75	32.7	7.7	147	2.3	3.8	0.139	138	61
18.5	M2BA 200 MLA	3GBA 203 041-••G	975	89.1	90.0	89.9	0.77	38.9	5.9	181	1.9	2.5	0.218	184	65
22 ¹⁾	M2BA 200 MLB	3GBA 203 042-••G	969	89.3	90.5	90.7	0.76	46.7	5.4	216	1.8	2.3	0.218	185	65
30	M2BA 225 SMA	3GBA 223 041-••G	985	90.6	91.0	90.4	0.83	57.5	7.0	290	2.4	2.8	0.547	317	65
37	M2BA 250 SMA	3GBA 253 041-••G	985	91.2	91.6	91.0	0.82	71.4	6.7	358	2.3	2.7	0.728	335	65

¹⁾ Temperature rise class F

The two bullets in the product code indicate choice of mounting arrangements, voltage and frequency code (see ordering information page).

I_s / I_N = Starting current
T_l / T_N = Locked rotor torque
T_b / T_N = Breakdown torque

Efficiency values are given according to IEC 60034-2-1; 2007.

Please note that the values are not comparable without knowing the testing method.

ABB has calculated the efficiency values according to indirect method, stray load losses (additional losses) determined from measuring.

General performance motors – variant codes

The following variant codes are available, more information from ABB. M = modification, NA = not applicable, S = standard

Code ¹⁾	Variant code	Aluminum motors						Cast iron motors		
		M2AA 56-250		90	100	112	132	160-250	M2BA 71-250	
		56-63	71-80							
Bearings and Lubrication										
037	Roller bearing at D-end.	NA	NA	M	M	M	M	M	NA	M
039	Cold resistant grease.	NA	M	M	M	M	M	NA	M	NA
040	Heat resistant grease.	NA	M	M	M	M	M	NA	M	S
041	Bearings regreasable via grease nipples.	NA	NA	NA	NA	NA	NA	NA	NA	S
057	2RS bearings at both ends.	NA	M	M	M	M	M	NA	NA	NA
188	63-series bearings.	NA	NA	M	S	S	M	M	NA	M
Branch standard designs										
178	Stainless steel / acid proof bolts.	NA	M	M	M	M	M	NA	M	M
217	Cast iron D-end shield	NA	NA	M	M	M	M	S	NA	NA
Cooling system										
053	Metal fan cover	S	M	M	M	M	M	S	NA	NA
068	Light alloy metal fan	NA	M	M	M	M	M	NA	M	M
Drain holes										
065	Plugged existing drain holes.	M	M	M	M	M	M	M	M	M
Earthing Bolt										
067	External earthing bolt.	M	M	M	M	M	M	M	M	M
Heating elements										
450	Heating element, 100-120V.	M	M	M	M	M	M	M	M	M
451	Heating element, 200-240V.	M	M	M	M	M	M	M	M	M
Mounting arrangements										
008	IM 2101 foot/flange mounted, IEC flange, from IM 1001 (B34 from B3).	M	M	M	M	M	M	NA	M	NA
009	IM 2001 foot/flange mounted, IEC flange, from IM 1001 (B35 from B3).	M	M	M	M	M	M	M	M	M
047	IM 3601 flange mounted, IEC flange, from IM 3001 (B14 from B5).	M	M	M	M	M	M	NA	M	NA
048	IM 3001 flange mounted, IEC flange, from IM 3601 (B5 from B14).	M	M	M	M	M	M	NA	M	NA
066	Modified for non-standard mounting position (please specify IM xxxx), (must be ordered for all mounting arrangements excluding IM B3 (1001), IM B5 (3001), IM B35 (2001), B34 (2101) & B14 (3601).	M	M	M	M	M	M	M	M	M
200	Flange ring holder	NA	M	M	M	M	M	NA	NA	NA
218	Flange ring FT 85	NA	M	M	NA	NA	NA	NA	NA	NA
219	Flange ring FT 100	NA	M	M	NA	NA	NA	NA	NA	NA
220	Flange ring FF 100	NA	M	M	NA	NA	NA	NA	NA	NA
223	Flange ring FF 115	NA	M	M	NA	NA	NA	NA	NA	NA
224	Flange ring FT 115	NA	M	M	M	M	NA	NA	NA	NA
226	Flange ring FF 130	NA	M	M	M	M	NA	NA	NA	NA
227	Flange ring FT 130	NA	M	M	M	M	NA	NA	NA	NA
229	Flange FT 130	NA	NA	NA	M	M	NA	NA	NA	NA
233	Flange ring FF 165	NA	M	M	M	M	NA	NA	NA	NA
234	Flange ring FT 165	NA	M	M	M	M	NA	NA	NA	NA
235	Flange FF 165	NA	NA	M	NA	NA	NA	NA	NA	NA
236	Flange FT 165	NA	NA	NA	NA	NA	M	NA	NA	NA
243	Flange ring FF 215	NA	NA	NA	M	M	M	NA	NA	NA
244	Flange ring FT 215	NA	NA	NA	M	M	M	NA	NA	NA
245	Flange FF 215	NA	NA	NA	M	M	NA	NA	NA	NA
253	Flange ring FF 265	NA	NA	NA	NA	NA	M	NA	NA	NA
254	Flange ring FT 265	NA	NA	NA	NA	NA	M	NA	NA	NA
255	Flange ring FT 265	NA	NA	NA	NA	NA	M	NA	NA	NA
260	Flange FT 115	NA	M	M	M	M	M	NA	NA	NA

Code ¹⁾	Variant code	Aluminum motors							Cast iron motors	
		M2AA 56-63	M2AA 71-80	90	100	112	132	160-250	M2BA 71-132	M2BA 160-250
Painting										
114	Special paint colour, standard grade.	NA	M	M	M	M	M	NA	M	M
Protection										
005	Metal protective roof, vertical motor, shaft down.	M	M	M	M	M	M	M	M	M
072	Radial seal at D-end.	NA	M	M	M	M	M	NA	M	NA
076	Draining holes with plugs in open position.	NA	NA	NA	NA	NA	NA	NA	NA	S
403	Degree of protection IP56.	M	M	M	M	M	M	NA	M	M
784	Gamma seal at D-end	NA	NA	M	M	M	M	NA	NA	NA
Rating & instruction plates										
002	Restamping voltage, frequency and output, continuous duty.	M	M	M	M	M	M	M	M	M
095	Restamping output (maintained voltage, frequency), intermittent duty.	M	M	M	M	M	M	M	M	M
098	Stainless rating plate.	M	M	M	M	M	M	M	M	S
138	Mounting of additional identification plate, aluminum.	M	M	M	M	M	M	NA	M	M
161	Additional rating plate delivered loose.	M	M	M	M	M	M	NA	M	M
198	Aluminum rating plate.	S	S	S	S	S	M	NA	NA	NA
Stator winding temperature sensors										
122	Bimetal detectors, break type (NCC), (3 in series), 150°C, in stator winding.	M	M	M	M	M	M	M	M	M
435	PTC - thermistors (3 in series), 130°C, in stator winding.	M	M	M	M	M	M	M	M	M
436	PTC - thermistors (3 in series), 150°C, in stator winding.	M	M	M	M	M	M	S	M	M
441	PTC - thermistors (3 in series, 130°C & 3 in series, 150°C), in stator winding.	NA	NA	NA	NA	NA	NA	M	NA	M
445	Pt-100 2-wire in stator winding, 1 per phase	NA	NA	NA	NA	NA	NA	M	NA	NA
Terminal box										
015	Motor supplied in D connection.	NA	M	M	M	M	M	NA	NA	NA
017	Motor supplied in Y connection.	NA	M	M	M	M	M	NA	NA	NA
230	Standard metal cable glands.	NA	M	M	M	M	M	M	M	M
375	Standard plastic cable gland	NA	M	M	M	M	M	NA	NA	NA
731	Two standard metal cable glands.	M	NA	NA	NA	NA	NA	NA	NA	NA
Testing										
145	Type test report from a catalogue motor, 400V 50Hz.	M	M	M	M	M	M	M	M	M
146	Type test with report for one motor from specific delivery batch	M	NA	NA	NA	NA	NA	NA	M	NA
147	Type test with report for one motor from specific delivery batch, customer witnessed.	M	NA	NA	NA	NA	NA	NA	M	NA
148	Routine test report.	M	M	M	M	M	M	M	M	M

General performance aluminum motors

Dimension drawings

M2AA 56 - 250

Foot-mounted motor IM1001, B3

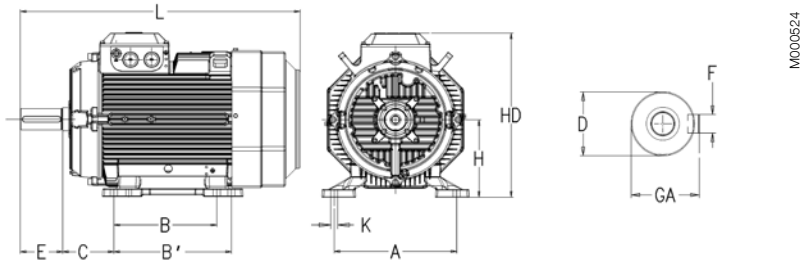

Flange-mounted motor IM 3001, B5

Sizes 56-200

Sizes 225-250

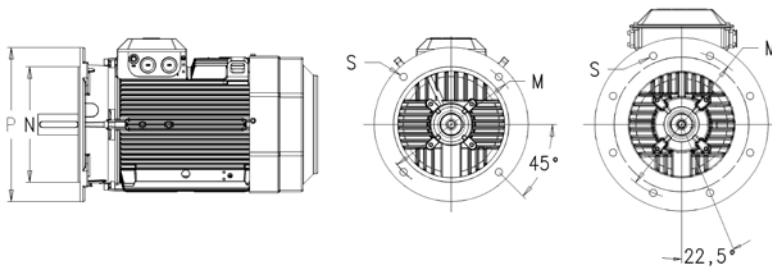

IM 1001, IM B3 and IM 3001, IM B5

IM 1001, IM B3

IM 3001, IM B5

Motor size	D poles		GA poles		F poles		E poles		L max poles		A	B	B'	C	HD	K	H	M	N	P	S
	2	4-6	2	4-6	2	4-6	2	4-6	2	4-6											
56	9	9	10,2	10,2	3	3	20	20	197	197	90	71	-	36	159	5,8	56	100	80	120	7
63	11	11	12,5	12,5	4	4	23	23	214	214	100	80	-	40	171	7	63	115	95	140	10
71	14	14	16	16	5	5	30	30	240	240	112	90	-	45	180	7	71	130	110	160	10
80	19	19	21,5	21,5	6	6	40	40	265,5	265,5	125	100	-	50	193,5	10	80	165	130	200	12
90 S	24	24	27	27	8	8	50	50	284,5	284,5	140	100	-	56	217	10	90	165	130	200	12
90 L	24	24	27	27	8	8	50	50	309,5	309,5	140	125	-	56	217	10	90	165	130	200	12
100	28	28	31	31	8	8	60	60	351	351	160	140	-	63	237	12	100	215	180	250	15
112	28	28	31	31	8	8	60	60	393	393	190	140	-	70	249	12	112	215	180	250	15
132 ¹⁾	38	38	41	41	10	10	80	80	447	447	216	140	178	89	295,5	12	132	265	230	300	14,5
132 ²⁾	38	38	41	41	10	10	80	80	550	550	216	140	178	89	321	15	132	265	230	300	14,5
160	42	42	45	45	12	12	110	110	584	584 ³⁾	254	210	254	108	370	14,5	160	300	250	350	19
180	48	48	51,5	51,5	14	14	110	110	681	681	279	241	279	121	390	14,5	180	300	250	350	19
200	55	55	59	59	16	16	110	110	726	726	318	267	305	133	425	18,5	200	350	300	400	19
225	55	60	59	64	16	18	110	140	821	851	356	286	311	149	525 ⁴⁾	18	225	400	350	450	19
250	60	65	64	69	18	18	140	140	880	880	406	311	349	168	572 ⁴⁾	22	250	500	450	550	19

IM 3601, IM B14

Motor size	M	N	P	S
56	65	50	80	M5
63	75	60	90	M5
71	85	70	105	M6
80	100	80	120	M6
90	115	95	140	M8
100	130	110	160	M8
112	130	110	160	M8
132 ¹⁾	165	130	200	M10
132 ²⁾	165	130	200	M10

Tolerances

A,B	±0,8
D	ISO k6 < Ø 50 mm
	ISO m6 > Ø 50 mm
F	ISO h9
H	-0,5
N	ISO j6
C	±0,8

¹⁾ M2AA 132 SA, SB, S, M, MA

²⁾ M2AA 132 SMA, SMC, SMD

³⁾ 160MLB 6-pole L=681

⁴⁾ For voltage code S add 32 mm to listed HD-dimension

Above table gives the main dimensions in mm. For detailed drawings please see our web-pages 'www.abb.com/motors&generators' or contact ABB.

General performance cast iron motors

Dimension drawings

M2BA 71 - 250

Foot-mounted motor IM1001, B3

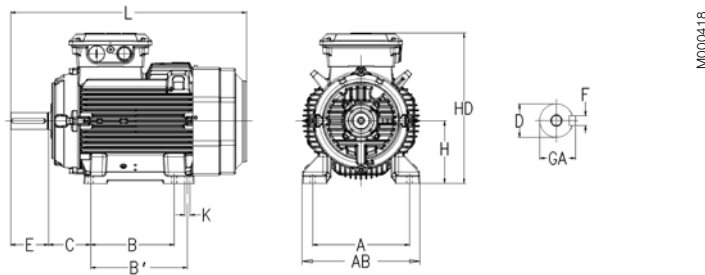

Flange-mounted motor IM 3001, B5

Sizes 71-200

Sizes 225-250

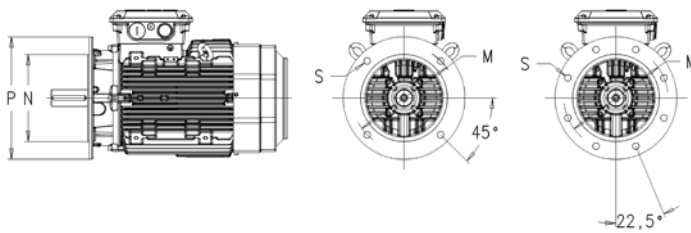

IM 1001, IM B3 and IM 3001, IM B5

IM 1001, IM B3

IM 3001, IM B5

Motor size	D poles		GA poles		F poles		E poles		L max poles		A	B	B'	C	HD	K	H	M	N	P	S
	2	4-6	2	4-6	2	4-6	2	4-6	2	4-6											
71	14	14	16	16	5	5	30	30	264	264	112	90	-	45	178	7	71	130	110	160	10
80	19	19	21.5	21.5	6	6	40	40	321	321	125	100	-	50	195	10	80	165	130	200	12
90S	24	24	27	27	8	8	50	50	357	357	140	100	-	56	219	10	90	165	130	200	12
90L	24	24	27	27	8	8	50	50	357	357	140	125	-	56	219	10	90	165	130	200	12
100	28	28	31	31	8	8	60	60	381	381	160	140	-	63	247	12	100	215	180	250	15
112	28	28	31	31	8	8	60	60	403	403	190	140	-	70	259	12	112	215	180	250	15
132S	38	38	41	41	10	10	80	80	533	533	216	140	-	89	300	12	132	265	230	300	15
132M	38	38	41	41	10	10	80	80	533	533	216	178	-	89	300	12	132	265	230	300	15
160	42	42	45	45	12	12	110	110	584	584 ¹⁾	254	210	254	108	413	14.5	160	300	250	350	19
180	48	48	51.5	51.5	14	14	110	110	681	681	279	241	279	121	433	14.5	180	300	250	350	19
200	55	55	59	59	16	16	110	110	726	726	318	267	305	133	473 ²⁾	18.5	200	350	300	400	19
225	55	60	59	64	16	18	110	140	821	851	356	286	311	149	539	18.5	225	400	350	450	19
250	60	65	64	69	18	18	140	140	879	879	406	311	349	168	584	24	250	500	450	550	19

IM 3601, IM B14

Motor size	M	N	P	S
71	85	70	105	M6
80	100	80	120	M6
90	115	95	140	M8
100	130	110	160	M8
112	130	110	160	M8
132	165	130	200	M10

Tolerances

A,B	±0,8
D	ISO k6 < Ø 50 mm
	ISO m6 > Ø 50 mm
F	ISO h9
H	-0,5
N	ISO j6
C	±0,8

¹⁾ 160MLB 6-pole L=681

²⁾ 200, voltage code S HD=478

Above table gives the main dimensions in mm. For detailed drawings please see our web-pages 'www.abb.com/motors&generators' or contact ABB.

General performance aluminum motors in brief

Motor size		56	63	71	80	90	100	112	132
Stator	Material	Diecast aluminum alloy.							
	Paint colour shade	Munsell blue 8B 4.5/3.25 / NCS 4822 B05G							
	Surface treatment	Epoxy polyester powder paint, $\geq 30\mu\text{m}$							
Feet		Fixed feet.							
	Material	Aluminum alloy							
Bearing end shields	Material	Diecast aluminum alloy							
	Paint colour shade	Munsell blue 8B 4.5/3.25 / NCS 4822 B05G							
	Surface treatment	Epoxy polyester powder paint, $\geq 30\mu\text{m}$				Polyester powder paint, $\geq 30\mu\text{m}$			
Bearings	D-end	6201-2Z/C3	6202-2Z/C3	6203-2Z/C3	6204-2Z/C3	6205-2Z/C3	6306-2Z/C3	6306-2Z/C3	6208-2Z/C3 ¹⁾
	N-end	6201-2Z/C3	6201-2Z/C3	6202-2Z/C3	6203-2Z/C3	6204-2Z/C3	6205-2Z/C3	6205-2Z/C3	6206-2Z/C3
Axially-locked bearings		D-end internal retaining ring				D-end inner bearing cover			
Bearing seals	D-end	V-ring							
Lubrication		Permanently lubricated shielded bearings. Grease temperature range -40 to +160°C							
Terminal box	Material	Diecast aluminum alloy, base integrated with stator.							
	Surface treatment	Similar to stator.							
	Screws	Steel 5G, galvanised.							
Connections	Knock-out openings	1 x M16 x Pg11		2 x (M20 + M20)		2 x (M20 + M25) ²⁾			
	Max Cu-area mm ²	2.5		4		6			10 ³⁾
	Terminal box	Cable lugs, 6 terminals				Screw terminal, 6 terminals			Cable lugs, 6 terminals
Fan	Material	Polypropylene. Reinforced with 20% glass fibre.							
Fan cover	Material	Polypropylene.							
	Paint colour shade	Black							
Stator winding	Material	Copper.							
	Impregnation	Polyester varnish. Tropicalised.							
	Insulation class	Insulation class F. Temperature rise class B, unless otherwise stated.							
Stator winding temperature sensors		Optional.							
Rotor winding	Material	Diecast aluminum.							
Balancing method		Half key balancing.							
Key ways		Closed keyway							
Heating elements	On request	8 W			25 W				
Enclosure		IP 55.							
Cooling method		IC 411.							
Drain holes		Drain holes with closable plugs, open on delivery.							
Lifting lugs		Integrated with the stator							

M2AA 132 SMA, SMC, SMD;

¹⁾ 6308-2Z/C3

²⁾ 2*(M40+M32+M12)

³⁾ 35

General performance aluminum motors in brief

Size	M2AA	160	180	200	225	250
Stator	Material	Diecast aluminum alloy			Extruded aluminum alloy.	
	Paint colour shade	Munsell blue 8B 4.5/3.25 / NCS 4822 B05G				
	Surface treatment	Polyester powder paint, $\geq 100\mu\text{m}$				
Feet		Bolt on feet, bolted to the stator.				
	Material	Aluminum alloy	Cast iron			
Bearing end shields	Material	Cast iron EN-GJL-200/GG 20/GRS 200				
	Paint colour shade	Munsell blue 8B 4.5/3.25 / NCS 4822 B05G				
	Surface treatment	Two-pack epoxy pain paint, $\geq 100\mu\text{m}$				
Bearings	D-end	6209-2Z/C3	6210-2Z/C3	6212-2Z/C3	6213-2Z/C3	6215-2Z/C3
	N-end	6209-2Z/C3	6209-2Z/C3	6209-2Z/C3	6210-2Z/C3	6212-2Z/C3
Axially-locked	Inner bearing cover	D-end				
Bearing seals		Axial seal				
Lubrication		Permanently lubricated shielded bearings. Wide temperature grease.				
Terminal box	Material	Diecast aluminum alloy, base integrated with stator.			Deep-drawn steel sheet, bolted to stator.	
	Surface treatment	Polyester powder paint, $\geq 100\mu\text{m}$			Phosphated. Polyester paint.	
	Screws	Steel 8.8, zinc electroplated and chromated				
Connections	Knock-out openings				2 x FL13, 2 x M40	
	Flange-openings	(2 x M40 + M16) + (2 x M40)			2 x FL 21, 2 x M63 (voltage code S)	
	Max Cu-area mm ²	35			70	
	Terminal box	6 terminals for connection with cable lugs (not included)				
	Screws	M6			M10	
Fan	Material	Polypropylene. Reinforced with 20% glass fibre.				
Fan cover	Material	Hot dip galvanized steel				
	Paint colour shade	Black, NCS 8801-B09G				
	Surface treatment	Polyester powder paint, $\geq 100\mu\text{m}$				
Stator winding	Material	Copper.				
	Impregnation	Polyester varnish.				
	Insulation class	Insulation class F. Temperature rise class B, unless otherwise stated.				
Stator winding temperature sensors		Optional.				
Rotor winding	Material	Diecast aluminum.				
Balancing method		Half key balancing.				
Key ways		Closed keyway				
Heating elements	Optional	25 W	50 W			
Enclosure		IP 55.				
Cooling method		IC 411.				
Drain holes		Drain holes with closable plastic plugs, open on delivery.				
Lifting lugs		Integrated with the stator			Bolted to the stator	

General performance cast iron motors in brief

Motor size		71	80	90	100	112	132
Stator	Material	Cast iron EN-GJL-150/GG 15/GRS 150					
	Paint colour shade	Munsell blue 8B 4.5/3.25 / NCS 4822 B05G					
	Surface treatment	Two-pack epoxy paint, $\geq 60\mu\text{m}$					
Feet		Fixed feet.					
	Material	Cast iron EN-GJL-150/GG 15/GRS 150					
Bearing end shields	Material	Cast iron EN-GJL-150/GG 15/GRS 150					
	Paint colour shade	Munsell blue 8B 4.5/3.25 / NCS 4822 B05G					
	Surface treatment	Two-pack epoxy paint, $\geq 60\mu\text{m}$					
Bearings	D-end	6203-2Z/C3	6204-2Z/C3	6205-2Z/C3	6206-2Z/C3	6206-2Z/C3	6208-2Z/C3
	N-end	6202-2Z/C3	6203-2Z/C3	6204-2Z/C3	6205-2Z/C3	6205-2Z/C3	6208-2Z/C3
Axially-locked bearings	Inner bearing cover	D-end					
Bearing seals	D-end	V-ring					
	N-end	Labyrinth seal					
Lubrication		Permanently lubricated shielded bearings. Grease temperature range -40 to $+160^\circ\text{C}$					
Terminal box	Material	Cast iron EN-GJL-150/GG 15/GRS 150					
	Surface treatment	Similar to stator.					
	Screws	Steel 5G, coated with zinc and yellow chromated.					
Connections	Threaded openings	2 x M16	2 x M25		2 x M32		
	Max Cu-area mm ²	4	6		10		
	Terminal box	Cable lugs, 6 terminals					
Fan	Material	Polypropylene. Reinforced with 20% glass fibre.					
	Material	Steel					
	Paint colour shade	Black RAL 9011					
Fan cover	Surface treatment	Two-pack epoxy paint, $\geq 60\mu\text{m}$					
Stator winding	Material	Copper.					
	Impregnation	Polyester varnish. Tropicalised.					
	Insulation class	Insulation class F. Temperature rise class B, unless otherwise stated.					
Stator winding temperature sensors		Optional.					
Rotor winding	Material	Diecast aluminum.					
Balancing method		Half key balancing as stated					
Key ways		Closed keyway					
Heating elements	On request	8 W	25 W				
Enclosure		IP 55.					
Cooling method		IC 411.					
Drain holes		Drain holes with closable plugs, open on delivery.					
Lifting lugs		Integrated with the stator					

General performance cast iron motors in brief

Size	M2BA	160	180	200	225	250
Stator	Material	Cast iron EN-GJL-200/GG 20/GRS 200				
	Paint colour shade	Munsell blue 8B 4.5/3.25 / NCS 4822 B05G				
	Surface treatment	Two-pack epoxy pain paint, $\geq 100\mu\text{m}$				
Feet		Integrated with stator				
	Material	Cast-iron				
Bearing end shields	Material	Cast iron EN-GJL-200/GG 20/GRS 200				
	Paint colour shade	Munsell blue 8B 4.5/3.25 / NCS 4822 B05G				
	Surface treatment	Two-pack epoxy pain paint, $\geq 100\mu\text{m}$				
Bearings	D-end	6209-2Z/C3	6210-2Z/C3	6212-2Z/C3	6213-2Z/C3	6215-2Z/C3
	N-end	6209-2Z/C3	6209-2Z/C3	6209-2Z/C3	6210-2Z/C3	6212-2Z/C3
Axially-locked	Inner bearing cover	D-end				
Bearing seals	D-end	Axial seal				
	N-end					
Lubrication		Permanently lubricated shielded bearings.				
Terminal box	Material	Cast iron, base integrated with stator.				
	Surface treatment	Two-pack epoxy pain paint, $\geq 100\mu\text{m}$				
	Screws	Steel 8.8, zinc electroplated and chromated				
Connections	Threaded openings	(2 x M40 + M16)			Code S M50+M40+M16	(2 x M63 + M16)
	Max Cu-area mm ²	35	Code S: 70			70
	Terminal box	6 terminals for connection with cable lugs (not included)				
	Screws	M6				M10
Fan	Material	Polypropylene. Reinforced with 20% glass fibre.				
Fan cover	Material	Hot dip galvanized steel				
	Paint colour shade	Black, NCS 8801-B09G				
	Surface treatment	Polyester powder paint, $\geq 100\mu\text{m}$				
Stator winding	Material	Copper.				
	Impregnation	Polyester varnish.				
	Insulation class	Insulation class F. Temperature rise class B, unless otherwise stated.				
Stator winding temperature sensors		Optional.				
Rotor winding	Material	Diecast aluminum.				
Balancing method		Half key balancing.				
Key ways		Closed keyway				
Heating elements	On request	25 W	50 W			
Enclosure		IP 55.				
Cooling method		IC 411.				
Drain holes		Drain holes with closable plastic plugs, open on delivery.				
Lifting lugs		Integrated with the stator (round motor bolted)				

ABB Motors' total product offer



ABB offers several comprehensive ranges of AC motors and generators. We manufacture synchronous motors for even the most demanding applications, and a full range of low and high voltage induction motors. Our in-depth knowledge of virtually every type of industrial processing ensures we always specify the best solution for your needs.

Low voltage motors and generators Process performance motors for more demanding applications

- Cast iron motors
- Premium efficiency motors
- NEMA motors

Industrial performance motors - flexibility for most customer applications

- Aluminum motors
- Steel motors
- Cast iron motors

General performance motors - out-of-the-box simplicity for high volume customers

- Aluminum motors
- Cast iron motors

Motors for hazardous areas

- Flameproof motors
- Increased safety motors
- Non-sparking motors
- Dust ignition proof motors

Marine motors

- Aluminum motors
- Steel motors
- Cast iron motors
- Open drip proof motors

Motors for additional applications

- Open drip proof motors
- Brake motors
- Single phase motors
- High ambient motors
- Permanent magnet motors
- High speed motors
- Wind turbine generators
- Smoke venting motors
- Water cooled motors
- Motors for roller table drives
- Servomotors

High voltage and synchronous motors and generators

- High voltage cast iron motors
- Induction modular motors
- Slip ring motors
- Motors for hazardous areas
- Synchronous motors and generators
- DC motors and generators
- Wind turbine generators
- Traction motors

Motors & Generators

> Motors

>> Low Voltage Motors

Process performance motors
 Industrial performance motors

>>> General performance motors

>>>> Aluminum motors
 >>>> Cast iron motors
 Motors for hazardous areas
 Marine motors
 Motors for additional applications

The screenshot shows the ABB website's 'Motors for All Applications' page. The header includes the ABB logo and navigation links like 'Home', 'About ABB', 'Products & services', 'News center', 'Careers', and 'Investor relations'. The main content area features a grid of motor categories: Low Voltage Motors, High Voltage Induction Motors, Motors for Hazardous Areas, Synchronous Motors, DC Motors, Motor Services, Servomotors and servodrives, and Traction Motors. A sidebar on the right contains a search bar, user preferences, and contact information for other countries.

The screenshot shows the ABB website's 'Low voltage motors' page. The main heading is 'Low voltage motors' with a sub-heading 'ABB launches low voltage AC motors with improved energy efficiency and lifecycle value. At the same time, the company has rearranged its standard motor portfolio into three ranges.' Below this, there are three columns of motor types: Standard motors (Process performance, General performance), Other applications (Motors for hazardous areas, Marine motors), and Industrial performance motors. A sidebar on the right provides search, preferences, and contact options.

The screenshot shows the ABB website's 'General performance motors' page. The main heading is 'General performance motors' with a sub-heading 'ABB's General performance motors are best suited for applications where simplicity and off-the-shelf availability are paramount. With ABB quality and support these motors have the features appreciated by volume customers and serial OEM's. Motors are of IE1 efficiency.' Below this, there are two columns of motor types: Aluminum motors (Motor type M2AA, IEC sizes 56 to 250, 0.06 to 55 kW) and Cast iron motors (Motor type M2BA, IEC sizes 71 to 250, 0.25 to 55 kW). A sidebar on the right contains search, preferences, and contact information.

Contact us

www.abb.com/motors&generators

© Copyright 2010 ABB.
All rights reserved.
Specifications subject to change
without notice.

9AKK1045592 EN 02-2010 Waasa Graphics Oy